



KAIM[®]

www.kaim.com.tr

ŞUBAT 2026
Fiyat Listesi

**Güncellenen
fiyat listelerimizi
QR CODE'larımızdan
takip edebilirsiniz.**

pdf



xlsx



www.kaim.com.tr

A

Alüminyum Ek Muflar	38
Alüminyum Buatlar	10
Alüminyum İletken Klemensler ve Kılıfı	33
Alüminyum Özel Klemensler	34
Alüminyum Askı Klemensi ve Kancası	34
Alüminyum Baralar ve Lamalar	37
Alüminyum SKP'ler	38
Alüminyum Bükme Ek Borular	34
Alüminyum Grup Prizler	27-28
Antigran Anahtar ve Prizler	25
Asansör Panoları	61
Aydınlatma Ürünleri	23-24
Ampermetre Sinyal	62
Arabalı Kombinasyonlar (Montajlı)	13-16
Al-Cu SKP'ler	35

B

Bakır SKP'ler	35-36
Bakır İletken Klemensler	43
Bakır Levhalar-Baralar-Lamalar	46
Bakır Bara Tutucuları	45
Bara Mesnedi	56
Bara Serfiller	58
Bimetalik SKP'ler ve Al-Cu SKP'ler	35
Boş Kombibasyonlar ve Buatlar	7-11
Boru Geçmeli Anahtar Kasaları	18
Branşman Klemensler	33
Buat Klemensleri	30
Butonlar ve Kutuları	62-63-64-65
Büro Tipi Grup Prizler ve Kanallar	26-27-28

C-Ç

CEE NORM Fiş ve Prizler	4-5-6
C Bakır Klemensler ve Pensesi	44
Çelik spiraller	21

D

Data Priz Kapağı ve Konnektörü	26
DIN SKP'ler	36
Direkt Şalterler	32
Döküm Buatlar	10
Dufaze W Otomat Barası	55
Duyular E14-E27-E40	25
Durdurucu Klemensler	33
Dübeller	24

E

Ek Muflar Bakır	39
Ek Muflar (Alüminyum)	38
Endirekt Şalterler	42
Eş Potansiyel Baralar	49
Etanj Buton Kutuları (Düz ve Delikli)	64
Etanj Armatürler	23
Etanj Rakorlar	22
FAB Alüminyum Bükme Ek Borular	34
Flatörler	31
Faz Baraları	56

G-H

Galveniz Kazıklar-Levhalar-Şeritler	46
Gem Tozu	45
Grup Prizler	27-28
H Klemensler ve Pensesi	44
Halojen Free Anahtar ve Priz Kasaları	18

I-İ

Isı Büzüşmeli Ek Muflar	40
İpli Switch	24
İzoleli U Klemensler	42
İzolatörler	58

K-L

Kablo Taşıma Rayı	57
Kauçuk Fiş ve Prizler	1
Kanca Serfiller	41
Kanal Prizleri	26
Kep Kep'li Telefon Dağıtım Kutuları	17
Kılavuzlar	21
Kombinasyon Kutuları (Boş ve 1x16 Prizli)	12
Kutulu Butonlar	60
Kutulu Pako Şalterler	66
Körüklü Rakorlar	10
Köşebentler	46
Kanca Tipi Bağlantı Klemensi	56
Kör Kapalar ve Somunları	22
Kolon Klemensleri	42
Kroşe Rayı ve Kroşeler	57
Ledli Ralina Ampul	24
Ledli Sinyaller	62

M

Makine Prizleri (Kauçuk)	1-2
Menteşeli Buatlar (Şeffaf ve Mat kapaklı)	9
Mesnet İzolatörler	58
Motor Klemensler	58
Montajlı Kombinasyonlar	11-12-13-14-15-16
Motor Koruma Şalterleri ve Kutusu	32
Monofaze W Otomat Baraları	56
Nemliyer Oval ve Yuvarlak Armatürler	23
Nemliyer Anahtar - Prizler	25
Nemliyer Sigorta Kutuları	19-20
Nihayet Şalterler (Metal ve Polyamid Gövde)	31
Nötr Baralar ve Papuç Takımı	56

O-Ö

Otomat Kutuları	19-20
Otomat Montajlı Kombinasyonlar	13-14-15-16
Otomat Rayları (Alüminyum ve Sac)	57
Ölüm Tehlikesi	46
Örgülü Bakır	46
Özel Alüminyum Klemensler	34

P

PAK 70 Klemens Kılıfı	33
Pako Kutuları	66
Pano Topraklama Klemensleri	50
Panolar	59
Pano Prizleri	2
Paratonerler	45
Pedal Butonlar	65
Perde Saclı W Otomat Kutuları	20-59
Priz Montajlı Kombinasyonlar	11-12-13
Porselen Klemensler	30
Protolin	39
Pirinç İletken Klemensler	43
Potansiyel Baralar	49
Push Butonlar	65
PVC Kaplı Çelik Spiraller	24

R

Ray Klemensler ve Köprüleri	47-48
Rakorlar (Etanj ve Körüklü)	10-22
Ralina Duyular	24
Ralina Armatürler ve Ampuller	24
Raylar - Kroşe Rayı	57
Raya Montajlı Pano Prizi	2
Reçine	39
Rozanslar	25
Rotatif Anahtar Priz	25

S-Ş

Sıkmalı Ek Muflar (Bakır)	39
Sıra Klemensler	29-30
Sıra Klemens İçleri	42
Sıva Altı Kare Buatlar	18
Sigorta Kutuları	19-20
Sigortalı Ray Klemensler	48
Sinyaller	62
Spiraller	21
SKP'ler ve Kılıfları	35-36-37-38
Su Seviye Şalterleri	31
Sustalar	21
Şalterler (Termik Manyetik)	32
Şantiye Panoları	61
Şebeke Prizleri (45x45)	26

T

Tandır Kroşeler	57
Takoz ve Topbaşı Klemensler	34
Tarak İzolatörleri	58
Termoplastik Buatlar (ABS)	9
Terminaller	51-52-53-54
Telefon Kutuları (Çatılı)	17
Telefon İrtibatlama Aleti ve Modülü	17
Tırnaklı Klemensler	43
Tij Takımı (Porselen Duyulu Pls. Kılıflı)	25
Topraklama Çubukları ve Levhaları	45
Topraklama Klemensleri	50
Topraklama Levhası Tek-Çift El	46

U-V

U Klemensler ve Kılıfları	42
Vidalı Dübeller	24
Vinç Butonları	65
Voltmetre Sinyal	62

W

W Otomat Rayları	57
W Otomat Kutuları	19-20

Y-Z

Yeraltı Buatlar ve Kanca Serfiller	41
Yuvarlak Armatürler (Nemliyer)	23
Zayıf Akım Buatları	19

1x16 Kauçuk Seri Fiş ve Prizler**IP44****1x16 A Kauçuk Düz Fiş**Kod : Z00441X
Kutu Adedi : 50**Fiyat: 77,00 TL****1x16 A Kauçuk Uzatma Prizi**Kod : Z00444X
Kutu Adedi : 30**Fiyat: 122,50 TL****1x16 A Kauçuk Tekli Duvar Prizi**Kod : Z00448X
Kutu Adedi : 20**Fiyat: 184,50 TL****1x16 A Kauçuk 2'li Grup Priz**Kod : Z00453X
Kutu Adedi : 10**Fiyat: 167,00 TL****1x16 A Kauçuk 3'lü Grup Priz****[Kovan Kontaktlı]**Kod : Z00442X
Kutu Adedi : 6**Fiyat: 313,80 TL****1x16 A Kauçuk 3'lü Grup Priz****[Şerit Kontaktlı]**Kod : Z00440X
Kutu Adedi : 8**Fiyat: 215,00 TL****3x25 Kauçuk Seri Fiş ve Prizler****IP44****3x25 A Kauçuk Trifaze Fiş**Kod : Z00503X
Kutu Adedi : 30**Fiyat: 183,50 TL****3x25 A Kauçuk Trifaze Uzatma Prizi**Kod : Z00509X
Kutu Adedi : 18**Fiyat: 221,50 TL****3x25 A Kauçuk Tekli Duvar Prizi**Kod : Z00511X
Kutu Adedi : 12**Fiyat: 225,50 TL****3x25 A 1 AD.+1x16 A 1 AD. Grup Priz**Kod : Z00506X
Kutu Adedi : 6**Fiyat: 481,00 TL****3x25 A 2 AD.+1x16 A 1 AD. Grup Priz**Kod : Z00507X
Kutu Adedi : 6**Fiyat: 673,50 TL****3x25 A 1 AD.+ 1x16 A 2 AD. Grup Priz**Kod : Z00515X
Kutu Adedi : 6**Fiyat: 642,00 TL****3x25 A 2'li Grup Priz**Kod : Z00510X
Kutu Adedi : 6**Fiyat: 513,00 TL****3x25 A 3'lü Grup Priz**Kod : Z00508X
Kutu Adedi : 6**Fiyat: 689,50 TL****Kontaklar
Kovan
Kontaktır**

1x16 Polyamid Fiş ve Prizler

IP44

1x16 A Pano Prizi Mavi



Kod : Z00443X
Kutu Adedi : 60

Fiyat: 97,70 TL

1x16 A Makine Prizi (75x75 Taban)



Kod : Z00445F
Kutu Adedi : 18

Fiyat: 196,30 TL

1x16 A Pano Prizi (68x68x63)



Kod : Z01550F
Kutu Adedi : 20

Fiyat: 206,40 TL

1x16 A Ray Tipi Priz (Yaylı Kapaklı)



Kod : Z00451F
Kutu Adedi : 50

Fiyat: 223,60 TL

1x16 A Duvar Prizi (85x85)



Kod : Z00446F
Kutu Adedi : 8

Fiyat: 275,50 TL

1x16 A Duvar Prizi (Otomat Takılabilir)

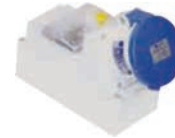

Kod : Z00450F
Kutu Adedi : 3

Fiyat: 482,00 TL

1x16 A Duvar Prizi+1x16 A Pano Prizi

[100x100 Eğik Gövdeli]



Kod : Z00447X
Kutu Adedi : 8

Fiyat: 430,50 TL

3x16 Polyamid Fiş ve Prizler

IP44

3x16 A Polyamid Düz Fiş



Kod : Z00463F
Kutu Adedi : 24

Fiyat: 256,40 TL

3x16 A Uzatma Prizi (Seyyar)



Kod : Z00464F
Kutu Adedi : 12

Fiyat: 298,80 TL

3x16 A Makine Prizi (75x75 Taban)



Kod : Z00460F
Kutu Adedi : 18

Fiyat: 256,40 TL

3x16 A Makine Fişi (75x75 Taban)



Kod : Z00465F
Kutu Adedi : 24

Fiyat: 223,60 TL

3x16 A Duvar Fişi

[100x100 Eğik Gövdeli]



Kod : Z00470F
Kutu Adedi : 8

Fiyat: 370,35 TL

3x16 A Duvar Prizi (85x85 Taban)



Kod : Z00461F
Kutu Adedi : 8

Fiyat: 402,00 TL

3x16 A Duvar Prizi+1x16 A Pano Prizi

[100x100 Eğik Gövdeli]



Kod : Z00462F
Kutu Adedi : 8

Fiyat: 497,00 TL

3x16 A Duvar Prizi (Otomat Takılabilir)



Kod : Z00469F
Kutu Adedi : 3

Fiyat: 550,50 TL

3x25 Polyamid Fiş ve Prizler**IP44****3x25 A Polyamid Düz Fiş**Kod : Z00502F
Kutu Adedi : 24**Fiyat: 327,00 TL****3x25 A Uzatma Prizi (Seyyar)**Kod : Z00509F
Kutu Adedi : 12**Fiyat: 394,30 TL****3x25 A Makine Prizi (75x75 Taban)**Kod : Z00501F
Kutu Adedi : 18**Fiyat: 260,40 TL****3x25 A Makine Fişi (75x75 Taban)**Kod : Z00516F
Kutu Adedi : 24**Fiyat: 237,30 TL****3x25 A Duvar Fişi****[100x100 Eğik Gövdeli]**Kod : Z00517F
Kutu Adedi : 8**Fiyat: 404,50 TL****3x25 A Duvar Prizi (Yuvarlak)**Kod : Z00512X
Kutu Adedi : 16**Fiyat: 302,60 TL****3x25 A Duvar Prizi (85x85)**Kod : Z00504F
Kutu Adedi : 8**Fiyat: 410,00 TL****3x25 A Duvar Prizi (Otomat takılabilir)**Kod : Z00513F
Kutu Adedi : 3**Fiyat: 568,60 TL****3x25 A Duvar Prizi+1x16 Pano Prizli****[100x100 Eğik Gövdeli]**Kod : Z00505F
Kutu Adedi : 8**Fiyat: 563,30 TL****3x32 Polyamid Fiş ve Prizler****IP44****3x32 A Polyamid Düz Fiş**Kod : Z00483F
Kutu Adedi : 15**Fiyat: 332,30 TL****3x32 A Uzatma Prizi (Seyyar)**Kod : Z00484F
Kutu Adedi : 12**Fiyat: 413,00 TL****3x32 A Makine Prizi (75x75 Taban)**Kod : Z00480F
Kutu Adedi : 18**Fiyat: 325,50 TL****3x32 A Makine Fişi (75x75 Taban)**Kod : Z00485F
Kutu Adedi : 12**Fiyat: 286,90 TL****3x32 A Duvar Fişi****[100x100 Eğik Gövdeli]**Kod : Z00489F
Kutu Adedi : 8**Fiyat: 446,00 TL****3x32 A Duvar Prizi (85x85 Taban)**Kod : Z00481F
Kutu Adedi : 8**Fiyat: 421,70 TL****3x32 A Duvar Prizi+1x16 Pano Prizi****[100x100 Eğik Gövdeli]**Kod : Z00482F
Kutu Adedi : 8**Fiyat: 582,40 TL****3x32 A Duvar Prizi (Otomat Takılabilir)**Kod : Z00487F
Kutu Adedi : 3**Fiyat: 648,80 TL**

3x16 CEE Norm Fiş ve Prizler [220V]

IP44

3x16 A Düz Fiş



Kod : Z00520F
Kutu Adedi : 24

Fiyat: 255,45 TL

3x16 A Uzatma Prizi [Seyyar]



Kod : Z00525F
Kutu Adedi : 20

Fiyat: 319,50 TL

3x16 A Düz Makine Prizi [65x75 Taban]



Kod : Z00523F
Kutu Adedi : 18

Fiyat: 279,45 TL

3x16 A Makine Fişi



Kod : Z00526F
Kutu Adedi : 12

Fiyat: 237,50 TL

3x16 A Duvar Prizi [85x85 Gövde]



Kod : Z00521F
Kutu Adedi : 8

Fiyat: 447,20 TL

Kablolar için etanj rakor kullanılmıştır

3x32 CEE Norm Fiş ve Prizler [220V]

IP44

3x32 A Düz Fiş



Kod : Z00540F
Kutu Adedi : 15

Fiyat: 389,50 TL

3x32 A Uzatma Prizi [Seyyar]



Kod : Z00545F
Kutu Adedi : 8

Fiyat: 447,90 TL

3x32 A Düz Makine Prizi [75x75 Taban]



Kod : Z00543F
Kutu Adedi : 12

Fiyat: 379,00 TL

3x32 A Makine Fişi [75x75 Taban]



Kod : Z00546F
Kutu Adedi : 8

Fiyat: 280,00 TL

3x32 A Duvar Prizi



[100x100 Eğik Gövdeli]

Kod : Z00541F
Kutu Adedi : 8

Fiyat: 532,00 TL

3x32 A Duvar Prizi+1x16 Pano Prizli



[100x100 Eğik Gövdeli]

Kod : Z00542F
Kutu Adedi : 8

Fiyat: 669,00 TL

3x32 A Duvar Fişi



[100x100 Eğik Gövdeli]

Kod : Z00547F
Kutu Adedi : 8

Fiyat: 469,60 TL

3x32 A Duvar Prizi [Otomat Takılabilir]



Kod : Z00544F
Kutu Adedi : 3

Fiyat: 720,00 TL

Kablolar için etanj rakoru kullanılmıştır



4x16 CEE Norm Fiş ve Prizler (380V~415V)

IP44

4x16 A Düz Fiş



Kod : Z00550F
Kutu Adedi : 20

Fiyat: 297,10 TL

4x16 A Uzatma Prizi (Seyyar)



Kod : Z00556F
Kutu Adedi :

Fiyat sorunuz

4x16 A Düz Makine Priz (75x75 Taban)



Kod : Z00553F
Kutu Adedi :

Fiyat Sorunuz

4x16 A Makine Fişi (75x75 Taban)



Kod : Z00557F
Kutu Adedi : 12

Fiyat: 323,50 TL

4x16 A Duvar Prizi



[100x100 Eğik Gövdeli]

Kod : Z00551F
Kutu Adedi : 9

Fiyat: 434,50 TL

4x16 A Duvar Prizi+1x16 Pano Prizli]



[100x100 Eğik Gövdeli]

Kod : Z00552F
Kutu Adedi : 8

Fiyat: 532,80 TL

4x16 A Duvar Fişi



[100x100 Eğik Gövdeli]

Kod : Z00558F
Kutu Adedi : 8

Fiyat: 434,80 TL

4x16 A Duvar Prizi (Otomat Takılabilir)



Kod : Z00554F
Kutu Adedi : 3

Fiyat: 819,20 TL

Kablolar için etanj rakor kullanılmıştır

4x32 CEE Norm Fiş ve Prizler (380V~415V)

IP44

4x32 A Düz Fiş



Kod : Z00560F
Kutu Adedi : 15

Fiyat: 449,50 TL

4x32 A Uzatma Prizi (Seyyar)



Kod : Z00566F
Kutu Adedi : 8

Fiyat: 492,80 TL

4x32 A Düz Makine Prizi (75x75 Taban)



Kod : Z00563F
Kutu Adedi : 12

Fiyat: 449,60 TL

4x32 A Makine Fişi (75x75 Taban)



Kod : Z00567F
Kutu Adedi : 8

Fiyat: 449,60 TL

4x32 A Duvar Prizi



[100x100 Eğik Gövdeli]

Kod : Z00561F
Kutu Adedi : 8

Fiyat: 594,60 TL

4x32 A Duvar Prizi+1x16 Pano Prizli



[100x100 Eğik Gövdeli]

Kod : Z00562F
Kutu Adedi : 8

Fiyat: 710,50 TL

4x32 A Duvar Fişi



[100x100 Eğik Gövdeli]

Kod : Z00568F
Kutu Adedi : 8

Fiyat: 559,90 TL

4x32 A Duvar Prizi (Otomat Takılabilir)



Kod : Z00564F
Kutu Adedi : 3

Fiyat: 816,50 TL

Kablolar için etanj rakor kullanılmıştır

5x16 CEE Norm Fiş ve Prizler (380-415V)

IP44

5x16 A Düz Fiş



Kod : Z00580F
Kutu Adedi : 15

Fiyat: 329,90 TL

5x16 A Uzatma Prizi (Seyyar)



Kod : Z00588F
Kutu Adedi : 12

Fiyat: 429,90 TL

5x16 A Düz Makine Prizi (85x95 Taban)



Kod : Z00585F
Kutu Adedi : 18

Fiyat: 399,50 TL

5x16 A Düz Makine Prizi (75x75 Taban)



Kod : Z00586F
Kutu Adedi : 18

Fiyat: 399,50 TL

5x16 A Makine Fişi (75x75 Taban)



Kod : Z00583F
Kutu Adedi : 18

Fiyat: 389,50 TL

5x16 A Duvar Prizi+1x16 A Pano Prizli



Kod : Z00582F
Kutu Adedi : 8

Fiyat: 619,70 TL

5x16 A Duvar Prizi

(100x100 Eğik Gövdeli)



Kod : Z00581F
Kutu Adedi : 8

Fiyat: 557,50 TL

5x16 A Duvar Fişi

(100x100 Eğik Gövdeli)



Kod : Z00589F
Kutu Adedi : 8

Fiyat: 481,90 TL

5x16 A Duvar Prizi (Otomat Takılabilir)



Kod : Z00584F
Kutu Adedi : 3

Fiyat: 716,90 TL

Kablolar için etanj rakor kullanılmıştır

5x32 CEE Norm Fiş ve Prizler (380-415V)

IP44

5x32 A Düz Fiş



Kod : Z00600F
Kutu Adedi : 12

Fiyat: 434,70 TL

5x32 A Uzatma Prizi (Seyyar)



Kod : Z00607F
Kutu Adedi : 8

Fiyat: 536,70 TL

5x32 A Düz Makine Prizi (85x95 Taban)



Kod : Z00603F
Kutu Adedi : 12

Fiyat: 499,80 TL

5x32 A Düz Makine Prizi (75x75 Taban)



Kod : Z00604F
Kutu Adedi : 12

Fiyat: 499,80 TL

5x32 A Makine Fişi (75x75 Taban)



Kod : Z00608F
Kutu Adedi : 9

Fiyat: 490,70 TL

5x32 A Duvar Prizi+1x16 A Pano Prizli



(100x100 Eğik Gövdeli)

Kod : Z00602F
Kutu Adedi : 8

Fiyat: 749,70 TL

5x32 A Duvar Prizi

(100x100 Eğik Gövdeli)



Kod : Z00601F
Kutu Adedi : 8

Fiyat: 627,50 TL

5x32 A Duvar Fişi

(100x100 Eğik Gövdeli)



Kod : Z00609F
Kutu Adedi : 8

Fiyat: 626,50 TL

5x32 A Duvar Prizi (Otomat Takılabilir)



Kod : Z00605F
Kutu Adedi : 3

Fiyat: 816,50 TL

Kablolar için etanj rakor kullanılmıştır

Vidasız - Mat Kapaklı Termoplastik Bualar
IP44

KOD	cinsi	KUTU AD.	ADET TL
Z00111F	Ø 75x45 (4 Çıkışlı)	68	82,50
Z00112F	Ø 90x50 (4 Çıkışlı)	40	92,50

KOD	cinsi	KUTU AD.	ADET TL
Z00001F	70x80x35 (4 Çıkışlı)	66	51,20
Z00003F	85x85x50 (6 Çıkışlı)	46	54,20
Z00010F	85x85x50 Sıva Üstü Anahtar Kasa	32	44,80
Z00109F	100x100x65 (7 Çıkışlı)	20	104,50
Z00110F	110x110x65 (7 Çıkışlı)	18	119,50

Vidalı - Mat Kapaklı Termoplastik Bualar
IP54

KOD	cinsi	KUTU AD.	ADET TL
Z01346F	Ø 75x45 (4 Çıkışlı)	68	85,50
Z01347F	Ø 90x50 (4 Çıkışlı)	40	96,40

KOD	cinsi	KUTU AD.	ADET TL
Z01350F	85x85x50 (6 Çıkışlı)	46	75,90
Z01351F	80x142x70 (8 Çıkışlı)	20	134,20
Z01364F	85x165x80 (8 Çıkışlı)	10	157,80
Z01365F	85x165x110 (8 Çıkışlı)	10	177,15
Z01352F	100x100x65 (7 Çıkışlı)	20	113,50
Z01345F	110x110x65 (7 Çıkışlı)	18	118,50
Z01353F	110x110x75 (7 Çıkışlı)	18	122,90
Z01349F	110x110x125 (7 Çıkışlı)	8	219,50
Z01354F	110x180x68 (8 Çıkışlı)	12	199,50
Z01355F	110x180x110 (8 Çıkışlı)	8	269,70
Z01366F	120x220x80 (8 Çıkışlı)	8	283,70
Z01367F	120x220x125 (8 Çıkışlı)	8	339,80
Z01356F	160x180x100 (12 Çıkışlı) MDL	6	319,50
Z01357F	160x250x100 (14 Çıkışlı) MDL	6	459,80
Z01358F	160x250x105/75 (14 Çıkışlı) Eğik	6	459,80
Z01359F	180x270x100 (12 Çıkışlı)	3	490,00
Z01360F	180x270x140 (12 Çıkışlı)	2	539,40
Z01361F	250x330x110 (16 Çıkışlı)	1	693,50
Z01362F	250x330x145 (16 Çıkışlı)	1	749,50

Vidalı - ABS Mat Kapaklı Etanj Termoplastik Buatlar

IP65



KOD	cinsi		KUTU AD.	ADET TL
Z00021F	ABS Ø 75X45	[4 Çıkışlı]	68	87,50
Z00022F	ABS Ø 90x50	[4 Çıkışlı]	40	98,50
Z00000F	ABS 85x85x50	[6 Çıkışlı]	46	87,90
Z00006F	ABS 80x142x70	[8 Çıkışlı]	20	147,80
Z00102F	ABS 85x165x80	[8 Çıkışlı]	10	179,60
Z00103F	ABS 85x165x110	[8 Çıkışlı]	10	195,60
Z00071F	ABS 100x100x65	[7 Çıkışlı]	20	129,90
Z00101F	ABS 110x110x65	[7 Çıkışlı]	18	179,50
Z00005F	ABS 110x110x75	[7 Çıkışlı]	18	189,50
Z00113F	ABS 110x110x125	[7 Çıkışlı]	8	259,50
Z00007F	ABS 110x180x68	[8 Çıkışlı]	12	245,60
Z00042F	ABS 110x180x110	[8 Çıkışlı]	8	315,50
Z00130F	ABS 120x220x80	[8 Çıkışlı]	8	344,00
Z00131F	ABS 120x220x125	[8 Çıkışlı]	8	369,70
Z00083F	ABS 160x180x100	[12 Çıkışlı] MDL.	6	349,50
Z00002F	ABS 160x250x110	[14 Çıkışlı] MDL.	6	489,50
Z00114F	ABS 160x250x105/75	[14 Çıkışlı] Eğik Sin.	6	499,50
Z00009F	ABS 180x270x100	[12 Çıkışlı]	3	511,50
Z00045F	ABS 180x270x140	[12 Çıkışlı]	2	589,50
Z00019F	ABS 250x330x110	[16 Çıkışlı]	1	789,50
Z00020F	ABS 250x330x145	[16 Çıkışlı]	1	855,10

ABS Malzemedden Üretilmiştir.

Vidalı - Halogen Free ABS Mat Kapaklı Etanj Termoplastik Buatlar

IP65



KOD	cinsi		KUTU AD.	ADET TL
Z01301F	ABS Ø 75X45	[4 Çıkışlı]	68	94,70
Z01302F	ABS Ø 90x50	[4 Çıkışlı]	40	107,80
Z01303F	ABS 85x85x50	[6 Çıkışlı]	46	96,70
Z01317F	ABS 85x165x180	[8 Çıkışlı]	10	196,90
Z01318F	ABS 85x165x110	[8 Çıkışlı]	10	214,50
Z01313F	ABS 100x100x65	[7 Çıkışlı]	20	142,90
Z01316F	ABS 110x110x65	[7 Çıkışlı]	18	196,90
Z01304F	ABS 110x110x75	[7 Çıkışlı]	18	207,90
Z01305F	ABS 110x180x68	[8 Çıkışlı]	12	269,50
Z01306F	ABS 110x180x110	[8 Çıkışlı]	8	346,50
Z01314F	ABS 120x220x80	[8 Çıkışlı]	8	378,40
Z01315F	ABS 120x220x125	[8 Çıkışlı]	8	405,90
Z01307F	ABS 160x180x100	[12 Çıkışlı] MDL.	6	383,90
Z01308F	ABS 160x250x110	[14 Çıkışlı] MDL.	6	537,90
Z01309F	ABS 180x270x100	[12 Çıkışlı]	3	564,90
Z01310F	ABS 180x270x140	[12 Çıkışlı]	2	647,50
Z01311F	ABS 250x330x110	[16 Çıkışlı]	1	867,10
Z01312F	ABS 250x330x145	[16 Çıkışlı]	1	939,50

Halogen Free (Alev Yalmaz)

Vidalı - Şeffaf Kapaklı Termoplastik Buatlar**IP65****Darbeye Dayanıklı Şeffaf Kapak**
Polikarbonattan Üretilmiştir.

KOD	CİNSİ		KUTU AD.	ADET TL
Z00008F	ABS 80x142x70	[8 Çıkışı]	20	169,20
Z00141F	ABS 85x165x80	[8 Çıkışı]	10	219,85
Z00142F	ABS 85x165x110	[8 Çıkışı]	10	242,70
Z00040F	ABS 110x180x68	[8 Çıkışı]	12	273,70
Z00041F	ABS 110x180x110	[8 Çıkışı]	8	355,20
Z00046F	ABS 120x220x80	[8 Çıkışı]	10	365,40
Z00047F	ABS 120x220x125	[8 Çıkışı]	8	454,75
Z00084F	ABS 160x180x100	[12 Çıkışı] MDL.	6	420,70
Z00004F	ABS 160x250x110	[14Çıkışı] MDL.	6	578,80
Z00043F	ABS 180x270x100	[12 Çıkışı]	3	756,60
Z00044F	ABS 180x270x140	[12 Çıkışı]	2	809,70
Z00062F	ABS 250x330x110	[16 Çıkışı]	1	1.007,80
Z00063F	ABS 250x330x145	[16 Çıkışı]	1	1.208,00

Şeffaf Kapaklı Menteşeli Termoplastik Buatlar**IP54****Darbeye Dayanıklı Şeffaf Kapak**
Polikarbonattan Üretilmiştir.

KOD	CİNSİ		KUTU AD.	ADET TL
Z00097F	ABS 80x142x70	[8 Çıkışı]	9	243,50
Z00098F	ABS 85x165x80	[8 Çıkışı]	10	270,80
Z00099F	ABS 85x165x110	[8 Çıkışı]	10	293,70
Z00034F	ABS 110x180x68	[8 Çıkışı]	12	387,60
Z00035F	ABS 110x180x110	[8 Çıkışı]	8	470,80
Z00048F	ABS 120x220x80	[8 Çıkışı]	6	476,60
Z00049F	ABS 120x220x125	[8 Çıkışı]	8	501,00
Z00082F	ABS 160x180x100	[12 Çıkışı] MDL.	8	530,30
Z00039F	ABS 160x250x110	[14Çıkışı] MDL.	6	673,00
Z00036F	ABS 180x270x100	[12 Çıkışı]	3	813,00
Z00037F	ABS 180x270x140	[12 Çıkışı]	2	893,70
Z00094F	ABS 250x330x110	[16 Çıkışı] Kilitli	1	1.252,00
Z00095F	ABS 250x330x145	[16 Çıkışı] Kilitli	1	1.405,20

Mat Kapaklı Menteşeli Termoplastik Buatlar**IP54**Z00079F
Z00080F

KOD	CİNSİ		KUTU AD.	ADET TL
Z00096F	ABS 80x142x70	[8 Çıkışı]	9	219,60
Z00151F	ABS 85x165x80	[8 Çıkışı]	10	253,60
Z00152F	ABS 85x165x110	[8 Çıkışı]	10	279,30
Z00030F	ABS 110x180x68	[8 Çıkışı]	12	348,50
Z00031F	ABS 110x180x110	[8 Çıkışı]	8	438,80
Z00051F	ABS 120x220x80	[8 Çıkışı]	6	443,00
Z00052F	ABS 120x220x125	[8 Çıkışı]	8	473,50
Z00081F	ABS 160x180x100	[12 Çıkışı] MDL.	6	501,00
Z00038F	ABS 160x250x110	[14Çıkışı] MDL.	6	614,80
Z00032F	ABS 180x270x100	[12 Çıkışı]	3	779,30
Z00033F	ABS 180x270x140	[12 Çıkışı]	2	862,00
Z00079F	ABS 250x330x110	[16 Çıkışı] Kilitli	1	1.228,00
Z00080F	ABS 250x330x145	[16 Çıkışı] Kilitli	1	1.380,70

Alüminyum Döküm Buatlar

IP65



KOD	Cinsi		KUTU AD.	ADET TL
Z01204X	80x80x54 Alüminyum	Döküm Buat	10	730,00
Z01206X	100x100x73 Alüminyum	Döküm Buat	10	1.050,00
Z01207X	85x130x72 Alüminyum	Döküm Buat	6	1.375,00
Z01208X	100x150x74 Alüminyum	Döküm Buat	6	2.116,00
Z01209X	120x120x70 Alüminyum	Döküm Buat	6	1.904,00
Z01210X	130x170x91 Alüminyum	Döküm Buat	6	2.687,00
Z01211X	130x190x90 Alüminyum	Döküm Buat	6	2.857,00
Z01214X	170x190x91 Alüminyum	Döküm Buat	4	2.984,00
Z01215X	180x330x92 Alüminyum	Döküm Buat	2	5.375,00
Z01216X	250x250x100 Alüminyum	Döküm Buat	2	5.714,00

Körüklü Rakorlar



KOD	Cinsi		KUTU AD.	ADET TL
Z01451F	PG 7	Delik Çapı 13 mm	300	8,65
Z01452F	PG 9	Delik Çapı 16 mm	200	9,10
Z01453F	PG 11	Delik Çapı 19 mm	200	9,70
Z01454F	PG 13.5	Delik Çapı 21 mm	200	10,10
Z01455F	PG 16	Delik Çapı 23 mm	200	10,70
Z01456F	PG 21	Delik Çapı 29 mm	150	12,10
Z01457F	PG 29	Delik Çapı 38 mm	100	19,50

Kombinasyon Çeşitleri



**KAIM®****Sipariş Üzerine Özel Kombinasyonlar Yapılabilir****Sinyalsiz Boş Kombinasyonlar****IP54**

Z00119F

Z00120F

KOD	cinsi	TAKILABİLİR OTOMAT AD.	KUTU AD.	ADET TL
Z00115F	110x180 Boş Kombinasyon	5	8	470,00
Z00116F	160x250 Boş Kombinasyon	7	4	599,00
Z00117F	180x270 Boş Kombinasyon	8	4	729,00
Z00118F	250x330 Boş Kombinasyon	12	3	864,00
Z00119F	250x490 Boş Kombinasyon Modüler	24	2	1.392,00
Z00120F	250x500 Boş Kombinasyon Modüler	12	2	1.413,00

Darbeye Dayanıklı Hammadde Kullanılmıştır.**Cam: Polikarbonat / Topraklama Klemensli / Centalı / W Otomat Raylı****Halojen Free İçin Fiyat Alınız.****Sinyalli ABS Boş Kombinasyonlar****IP65**

Z00067F

KOD	cinsi	TAKILABİLİR OTOMAT AD.	KUTU AD.	ADET TL
Z00011F	ABS 160x250 Boş Kombinasyon Sinyalli	7	4	587,00
Z00016F	ABS 180x270 Boş Kombinasyon Sinyalli	8	4	748,00
Z00065F	ABS 250x330 Boş Kombinasyon Sinyalli	12	3	911,00
Z00067F	ABS 250x490 Boş Kombinasyon Sinyalli	24	2	1.740,00
Z00072F	ABS 250x500 Boş Kombinasyon Sinyalli	12	2	1.766,00

Darbeye Dayanıklı Hammadde Kullanılmıştır.**Cam: Polikarbonat / Topraklama Klemensli / Sinyal Lambalı / Centalı / W Otomat Raylı****Halojen Free İçin Fiyat Alınız.****Sinyalsiz Priz Montajlı ABS Kombinasyonlar****IP54**

KOD	cinsi	TAKILABİLİR OTOMAT AD.	KUTU AD.	ADET TL
Z00017F	110x180 - 2 Ad. 1/16 Pano Prizli	5	2	750,00
Z00013F	160x250 - 2 Ad. 1/16 Pano Prizli	7	2	878,00
Z00070F	160x250 - 3 Ad. 1/16 Pano Prizli	7	2	1.018,00
Z00018F	180x270 - 2 Ad. 1/16 Pano Prizli	8	2	1.055,00
Z00066F	250x330 - 2 Ad. 1x16 Pano Prizli	12	2	1.145,00
Z00069F	250x330 - 4 Ad. 1x16 Pano Prizli	12	2	1.425,00
Z00058F	250x330 - 10 Ad. 1x16 Pano Prizli	12	2	2.260,00
Z00068F	250x490 - 4 Ad. 1x16 Prizli Modüler	24	2	1.950,00
Z00073F	250x500 - 4 Ad. 1x16 Prizli Modüler	12	2	1.975,00

Cam: Polikarbonat / Topraklama Klemensli / Tasarım Patentli**Halojen Free İçin Fiyat Alınız.****85x165 Priz Montajlı Kombinasyonlar****IP54**

KOD	cinsi	MAKİNE PRİZ AD.	KUTU AD.	ADET TL
Z00161F	1x16 A Priz	1	3	680,00
Z00162F	3x16 A Priz	1	3	730,00
Z00163F	3x25 A Priz	1	3	750,00
Z00164F	3x32 A Priz	1	3	848,00
Z00165F	3x16 A Priz CEE Norm 220 Volt	1	3	-
Z00166F	3x32 A Priz CEE Norm 220 Volt	1	3	950,00
Z00167F	4x16 A Priz CEE Norm	1	3	950,00
Z00168F	4x32 A Priz CEE Norm	1	3	999,00
Z00169F	5x16 A Priz CEE Norm	1	3	950,00
Z00170F	5x32 A Priz CEE Norm	1	3	1.020,00

1Ad.Makine Prizi**1 Ad. 1x16 Pano Prizi****Topraklama Klemensli****4 Adet W Otomat Takılabilir**

110x180 Priz Montajlı Kombinasyon

IP54



1 Ad. Makine Prizi
2 Ad. 1x16 Pano Prizi
Topraklama Klemensli

KOD	cinsi	MAKİNE PRİZ AD.	KUTU AD.	ADET TL
Z00186F	1x16 A Priz 220 Volt	1	2	920,00
Z00187F	3x16 A Priz	1	2	990,00
Z00188F	3x25 A Priz	1	2	990,00
Z00189F	3x32 A Priz	1	2	1.100,00
Z00190F	3x16 A Priz CEE Norm 220 Volt	1	2	1.150,00
Z00191F	3x32 A Priz CEE Norm 220 Volt	1	2	1.200,00
Z00195F	4x16 A Priz CEE Norm	1	2	1.110,00
Z00192F	4x32 A Priz CEE Norm	1	2	1.250,00
Z00193F	5x16 A Priz CEE Norm	1	2	1.200,00
Z00194F	5x32 A Priz CEE Norm	1	2	1.300,00

5 Adet W Otomat Takılabilir

160x250 Priz Montajlı Kombinasyon

IP54



1 Ad. Makine Prizi
3 Ad. 1x16 Pano Prizi
Topraklama Klemensli

KOD	cinsi	MAKİNE PRİZ AD.	KUTU AD.	ADET TL
Z00621F	3x16 A Priz	1	2	1.250,00
Z00622F	3x25 A Priz	1	2	1.250,00
Z00623F	3x32 A Priz	1	2	1.550,00
Z00624F	3x16 A Priz CEE Norm 220 Volt	1	2	1.200,00
Z00625F	3x32 A Priz CEE Norm 220 Volt	1	2	1.320,00
Z00626F	4x16 A Priz CEE Norm	1	2	1.350,00
Z00627F	4x32 A Priz CEE Norm	1	2	1.450,00
Z00628F	5x16 A Priz CEE Norm	1	2	1.450,00
Z00629F	5x32 A Priz CEE Norm	1	2	1.750,00

7 Adet W Otomat Takılabilir

160x250 Priz Montajlı Kombinasyon

IP54



2 Ad. Makine Prizi
2 Ad. 1x16 Pano Prizi
Topraklama Klemensli

KOD	cinsi	MAKİNE PRİZ AD.	KUTU AD.	ADET TL
Z00201F	3x16 A Priz	2	2	1.400,00
Z00202F	3x25 A Priz	2	2	1.400,00
Z00203F	3x32 A Priz	2	2	1.800,00
Z00204F	3x16 A Priz CEE Norm 220 Volt	2	2	1.350,00
Z00205F	3x32 A Priz CEE Norm 220 Volt	2	2	1.550,00
Z00206F	4x16 A Priz CEE Norm	2	2	1.580,00
Z00207F	5x16 A Priz CEE Norm	2	2	1.700,00

7 Adet W Otomat Takılabilir

180x270 Priz Montajlı Kombinasyon

IP54



2 Ad. Makine Prizi
2 Ad. 1x16 Pano Prizi
Topraklama Klemensli

KOD	cinsi	MAKİNE PRİZ AD.	KUTU AD.	ADET TL
Z00216F	3x16 A Priz	2	2	1.430,00
Z00230F	3x25 A Priz	2	2	1.430,00
Z00231F	3x32 A Priz	2	2	1.950,00
Z00217F	3x16 A Priz CEE Norm 220 Volt	2	2	1.450,00
Z00218F	3x32 A Priz CEE Norm 220 Volt	2	2	1.550,00
Z00219F	4x16 A Priz CEE Norm	2	2	1.670,00
Z00235F	4x32 A Priz CEE Norm	2	2	1.950,00
Z00220F	5x16 A Priz CEE Norm	2	2	1.850,00
Z00236F	5x32 A Priz CEE Norm	2	2	2.050,00

8 Adet W Otomat Takılabilir

250x330 Priz Montajlı Kombinasyon

IP54



2 Ad. Makine Prizi
2 Ad. 1x16 Pano Prizi
Topraklama Klemensli

KOD	cinsi	MAKİNE PRİZ AD.	KUTU AD.	ADET TL
Z01018F	3x16 A Priz	2	2	1.600,00
Z01019F	3x25 A Priz	2	2	1.600,00
Z01020F	3x32 A Priz	2	2	2.100,00
Z01021F	3x16 A Priz CEE Norm 220 Volt	2	2	1.550,00
Z01022F	3x32 A Priz CEE Norm 220 Volt	2	2	1.785,00
Z01023F	4x16 A Priz CEE Norm	2	2	1.820,00
Z01024F	4x32 A Priz CEE Norm	2	2	2.100,00
Z01025F	5x16 A Priz CEE Norm	2	2	1.990,00
Z01026F	5x32 A Priz CEE Norm	2	2	2.190,00

12 Adet W Otomat Takılabilir

Sipariş Üzerine Özel Kombinasyonlar Yapılabilir
250x330 Priz Montajlı Kombinasyon
IP54

2 Ad. Makine Prizi
10 Ad. 1x16 Pano Prizi
Topraklama Klemensli

KOD	cinsi	MAKİNE PRİZ AD.	KUTU AD.	ADET TL
Z00651F	3x16 A Priz	2	2	2.942,00
Z00652F	3x25 A Priz	2	2	2.942,00
Z00653F	3x32 A Priz	2	2	3.112,00
Z00654F	3x16 A Priz CEE Norm 220 Volt	2	2	2.983,00
Z00655F	3x32 A Priz CEE Norm 220 Volt	2	2	3.246,00
Z00656F	4x16 A Priz CEE Norm	2	2	3.258,00
Z00657F	4x32 A Priz CEE Norm	2	2	3.424,00
Z00658F	5x16 A Priz CEE Norm	2	2	3.515,00
Z00659F	5x32 A Priz CEE Norm	2	2	3.548,00

12 Adet W Otomat Takılabilir
250X330 Priz Montajlı Kombinasyon
IP54

2 Ad. Makine Prizi
4 Ad. 1x16 Pano Prizi
Topraklama Klemensli

KOD	cinsi	MAKİNE PRİZ AD.	KUTU AD.	ADET TL
Z00775F	3x16 A Priz	2	2	1.810,00
Z00776F	3x25 A Priz	2	2	1.810,00
Z00777F	3x32 A Priz	2	2	2.300,00
Z00778F	3x16 A Priz CEE Norm 220 Volt	2	2	1.750,00
Z00779F	3x32 A Priz CEE Norm 220 Volt	2	2	1.985,00
Z00780F	4x16 A Priz CEE Norm	2	2	2.020,00
Z00781F	4x32 A Priz CEE Norm	2	2	2.300,00
Z00783F	5x16 A Priz CEE Norm	2	2	2.275,00
Z00784F	5x32 A Priz CEE Norm	2	2	2.420,00

12 Adet W Otomat Takılabilir
250x330 Priz Montajlı Kombinasyon
IP54

3 Ad. Makine Prizi
2 Ad. 1x16 Pano Prizi
Topraklama Klemensli

KOD	cinsi	MAKİNE PRİZ AD.	KUTU AD.	ADET TL
Z00241F	3x16 A Priz	3	2	2.290,00
Z00242F	3x25 A Priz	3	2	2.290,00
Z00243F	3x32 A Priz	3	2	2.546,00
Z00244F	3x16 A Priz CEE Norm 220 Volt	3	2	2.353,00
Z00245F	3x32 A Priz CEE Norm 220 Volt	3	2	2.746,00
Z00246F	4x16 A Priz CEE Norm	3	2	2.825,00
Z00247F	4x32 A Priz CEE Norm	3	2	3.013,00
Z00248F	5x16 A Priz CEE Norm	3	2	3.015,00
Z00249F	5x32 A Priz CEE Norm	3	2	3.200,00

12 Adet W Otomat Takılabilir
250x330 Priz Montajlı Kombinasyon
IP54

4 Ad. Makine Prizi
4 Ad. 1x16 Pano Prizi
Topraklama Klemensli

KOD	cinsi	MAKİNE PRİZ AD.	KUTU AD.	ADET TL
Z00680F	3x16 A Priz	4	2	2.704,00
Z00681F	3x25 A Priz	4	2	2.704,00
Z00682F	3x32 A Priz	4	2	3.047,00
Z00683F	3x16 A Priz CEE Norm 220 Volt	4	2	2.789,00
Z00684F	3x32 A Priz CEE Norm 220 Volt	4	2	3.314,00
Z00685F	4x16 A Priz CEE Norm	4	2	3.188,00
Z00686F	4x32 A Priz CEE Norm	4	2	3.669,00
Z00687F	5x16 A Priz CEE Norm	4	2	3.647,00
Z00688F	5x32 A Priz CEE Norm	4	2	3.919,00

12 Adet W Otomat Takılabilir
250x330 Priz Montajlı Arabalı Kombinasyon
IP54

4 Ad. Makine Prizi
4 Ad. 1x16 Pano Prizi

KOD	cinsi	MAKİNE PRİZ AD.	KUTU AD.	ADET TL
Z00731F	3x16 A Priz	4	1	6.703,00
Z00732F	3x25 A Priz	4	1	6.922,00
Z00733F	3x32 A Priz	4	1	7.336,00
Z00734F	3x16 A Priz CEE Norm 220 Volt	4	1	6.637,00
Z00735F	3x32 A Priz CEE Norm 220 Volt	4	1	7.034,00
Z00738F	4x16 A Priz CEE Norm	4	1	7.579,00
Z00739F	4x32 A Priz CEE Norm	4	1	7.905,00
Z00736F	5x16 A Priz CEE Norm	4	1	8.086,00
Z00737F	5x32 A Priz CEE Norm	4	1	9.144,00

24 Adet W Otomat Takılabilir

85x165 Otomat Montajlı Kombinasyonlar

IP54



1 Ad. Makine Prizi
1 Ad. 1x16 Pano Prizi
Topraklama Klemensli

KOD	MAKİNE PRİZ AD.	TRİFAZE OTOMAT AD.	MONOFAZE OTOMAT AD.	KUTU AD.	ADET TL
Z00832F	3x16 A 1 AD.	3x16 A 1 AD.	1x16 1 AD.	3	2.862,00
Z00833F	3x25 A 1 AD.	3x25 A 1 AD.	1x16 1 AD.	3	2.914,00
Z00834F	3x32 A 1 AD.	3x32 A 1 AD.	1x16 1 AD.	3	3.207,00
Z00835F	3x16 A CEE 1 AD. 220 V	-	1x16 2 AD.	3	-
Z00836F	3x32 A CEE 1 AD. 220 V	-	1x16 1 AD. 1x32 1 AD.	3	1.672,00
Z00837F	4x16 A CEE 1 AD.	3x16 A 1 AD.	1x16 1 AD.	3	3.258,00
Z00838F	4x32 A CEE 1 AD.	3x32 A 1 AD.	1x16 1 AD.	3	3.465,00
Z00839F	5x16 A CEE 1 AD.	3x16 A 1 AD.	1x16 1 AD.	3	3.345,00
Z00840F	5x32 A CEE 1 AD.	3x32 A 1 AD.	1x16 1 AD.	3	3.607,00

110x180 Otomat Montajlı Kombinasyonlar

IP54



1 Ad. Makine Prizi
2 Ad. 1x16 Pano Prizi
Topraklama Klemensli

KOD	MAKİNE PRİZ AD.	TRİFAZE OTOMAT AD.	MONOFAZE OTOMAT AD.	KUTU AD.	ADET TL
Z00802F	3x16 A 1 AD.	3x16 A 1 AD.	1x16 1 AD.	2	3.190,00
Z00803F	3x25 A 1 AD.	3x25 A 1 AD.	1x16 1 AD.	2	3.241,00
Z00804F	3x32 A 1 AD.	3x32 A 1 AD.	1x16 1 AD.	2	3.517,00
Z00805F	3x16 A CEE 1 AD. 220 V	-	1x16 2 AD.	2	1.707,00
Z00806F	3x32 A CEE 1 AD. 220 V	-	1x16 1 AD. 1x32 1 AD.	2	1.983,00
Z00807F	4x16 A CEE 1 AD.	3x16 A 1 AD.	1x16 1 AD.	2	3.793,00
Z00808F	4x32 A CEE 1 AD.	3x32 A 1 AD.	1x16 1 AD.	2	4.138,00
Z00809F	5x16 A CEE 1 AD.	3x16 A 1 AD.	1x16 1 AD.	2	3.880,00
Z00810F	5x32 A CEE 1 AD.	3x32 A 1 AD.	1x16 1 AD.	2	4.362,00

160x250 Sinyalli Otomat Montajlı Kombinasyonlar

IP54



1 Ad. Makine Prizi
3 Ad. 1x16 Pano Prizi
Topraklama Klemensli
Sinyal Lambalı

KOD	MAKİNE PRİZ AD.	TRİFAZE OTOMAT AD.	MONOFAZE OTOMAT AD.	KUTU AD.	ADET TL
Z00634F	3x16 A 1 AD.	3x16 A 1 AD.	1x16 1 AD.	2	3.741,00
Z00635F	3x25 A 1 AD.	3x25 A 1 AD.	1x16 1 AD.	2	3.827,00
Z00636F	3x32 A 1 AD.	3x32 A 1 AD.	1x16 1 AD.	2	4.190,00
Z00637F	3x16 A CEE 1 AD. 220 V	-	1x16 2 AD.	2	2.293,00
Z00638F	3x32 A CEE 1 AD. 220 V	-	1x16 1 AD. 1x32 1 AD.	2	2.594,00
Z00639F	4x16 A CEE 1 AD.	3x16 A 1 AD.	1x16 1 AD.	2	4.345,00
Z00640F	4x32 A CEE 1 AD.	3x32 A 1 AD.	1x16 1 AD.	2	4.655,00
Z00641F	5x16 A CEE 1 AD.	3x16 A 1 AD.	1x16 1 AD.	2	4.465,00
Z00642F	5x32 A CEE 1 AD.	3x32 A 1 AD.	1x16 1 AD.	2	5.086,00

160x250 Sinyalli Otomat Montajlı Kombinasyonlar

IP54



2 Ad. Makine Prizi
2 Ad. 1x16 Pano Prizi
Topraklama Klemensli
Sinyal Lambalı

KOD	MAKİNE PRİZ AD.	TRİFAZE OTOMAT AD.	MONOFAZE OTOMAT AD.	KUTU AD.	ADET TL
Z00716F	3x16 A 2 AD.	3x20 A 1 AD.	1x16 1 AD.	2	3.914,00
Z00717F	3x25 A 2 AD.	3x32 A 1 AD.	1x16 1 AD.	2	4.241,00
Z00718F	3x32 A 2 AD.	3x40 A 1 AD.	1x16 1 AD.	2	4.793,00
Z00719F	3x16 A CEE 2 AD. 220 V	-	1x16 3 AD.	2	3.155,00
Z00720F	3x32 A CEE 2 AD. 220 V	-	1x16 1 AD. 1x32 2 AD.	2	3.625,00
Z00721F	4x16 A CEE 2 AD.	3x20 A 1 AD.	1x16 1 AD.	2	4.862,00
Z00722F	5x16 A CEE 2 AD.	3x20 A 1 AD.	1x16 1 AD.	2	5.224,00

180x270 Sinyalli Otomat Montajlı Kombinasyonlar
IP54

2 Ad. Makine Prizi
2 Ad. 1x16 Pano Prizi
Topraklama Klemensli
Sinyal Lambalı

KOD	MAKİNE PRİZ AD.	TRİFAZE OTOMAT AD.	MONOFAZE OTOMAT AD.	KUTU AD.	ADET TL
Z00856F	3x16 A 2 AD.	3x16 A 2 AD.	1x16 A 1 AD.	2	5.862,00
Z00857F	3x25 A 2 AD.	3x25 A 2 AD.	1x16 A 1 AD.	2	6.206,00
Z00858F	3x32 A 2 AD.	3x32 A 2 AD.	1x16 A 1 AD.	2	7.275,00
Z00859F	3x16 A CEE 2 AD. 220 V	-	1x16 A 3 AD.	2	3.655,00
Z00860F	3x32 A CEE 2 AD. 220V	-	1x16 A 1 AD. 1x32 A 2 AD.	2	3.965,00
Z00861F	4x16 A CEE 2 AD.	3x16 A 2 AD.	1x16 A 1 AD.	2	6.605,00
Z00862F	4x32 A CEE 2 AD.	3x32 A 2 AD.	1x16 A 1 AD.	2	7.430,00
Z00863F	5x16 A CEE 2 AD.	3x16 A 2 AD.	1x16 A 1 AD.	2	6.845,00
Z00864F	5x32 A CEE 2 AD.	3x32 A 2 AD.	1x16 A 1 AD.	2	7.880,00

250x330 Sinyalli Otomat Montajlı Kombinasyonlar
IP54

2 Ad. Makine Prizi
10 Ad. 1x16 Pano Prizi
Topraklama Klemensli
Sinyal Lambalı

KOD	MAKİNE PRİZ AD.	TRİFAZE OTOMAT AD.	MONOFAZE OTOMAT AD.	KUTU AD.	ADET TL
Z00821F	3x16 A 2 AD.	3x16 A 2 AD.	1x16 A 5 AD.	2	7.586,00
Z00822F	3x25 A 2 AD.	3x25 A 2 AD.	1x16 A 5 AD.	2	7.930,00
Z00823F	3x32 A 2 AD.	3x32 A 2 AD.	1x16 A 5 AD.	2	8.569,00
Z00824F	3x16 A CEE 2 AD. 220 V	-	1x16 A 7 AD.	2	5.520,00
Z00825F	3x32 A CEE 2 AD. 220V	-	1x16 A 5 AD. 1x32 A 2 AD.	2	5.865,00
Z00826F	4x16 A CEE 2 AD.	3x16 A 2 AD.	1x16 A 5 AD.	2	8.190,00
Z00827F	4x32 A CEE 2 AD.	3x32 A 2 AD.	1x16 A 5 AD.	2	9.070,00
Z00828F	5x16 A CEE 2 AD.	3x16 A 2 AD.	1x16 A 5 AD.	2	8.795,00
Z00829F	5x32 A CEE 2 AD.	3x32 A 2 AD.	1x16 A 5AD.	2	9.810,00



10 Ad. 1x16 Pano Prizi
Topraklama Klemensli
Sinyal Lambalı

KOD	MAKİNE PRİZ AD.	TRİFAZE OTOMAT AD.	MONOFAZE OTOMAT AD.	KUTU AD.	ADET TL
Z00941F	1x16A 10 AD.	-	1x16 A 5 AD.	2	6.725,00

250x330 Sinyalli Otomat Montajlı Kombinasyonlar
IP54

2 Ad. Makine Prizi
4 Ad. 1x16 Pano Prizi
Topraklama Klemensli
Sinyal Lambalı

KOD	MAKİNE PRİZ AD.	TRİFAZE OTOMAT AD.	MONOFAZE OTOMAT AD.	KUTU AD.	ADET TL
Z00926F	3x16 A 2 AD.	3x16 A 2 AD.	1x16 A 2 AD.	2	6.930,00
Z00927F	3x25 A 2 AD.	3x25 A 2 AD.	1x16 A 2 AD.	2	7.310,00
Z00928F	3x32 A 2 AD.	3x32 A 2 AD.	1x16 A 2 AD.	2	8.138,00
Z00929F	3x16 A CEE 2 AD. 220 V	-	1x16 A 4 AD.	2	4.775,00
Z00930F	3x32 A CEE 2 AD. 220V	-	1x16 A 2 AD. 1x32 A 2 AD.	2	6.880,00
Z00931F	4x16 A CEE 2 AD.	3x16 A 2 AD.	1x16 A 2 AD.	2	7.550,00
Z00932F	4x32 A CEE 2 AD.	3x32 A 2 AD.	1x16 A 2 AD.	2	8.608,00
Z00933F	5x16 A CEE 2 AD.	3x16 A 2 AD.	1x16 A 2 AD.	2	7.895,00
Z00934F	5x32 A CEE 2 AD.	3x32 A 2 AD.	1x16 A 2 AD.	2	9.172,00

250x330 Kaçak Akım Korumalı-Otomat Montajlı Hazır Kombinasyon

IP54



2 Ad. Makina Priz
2 Ad. 1x16 Pano Priz
Sinyal Lambalı

KAÇAK AKIM KORUMALI

KOD	MAKİNE PRİZ AD.	TRF OTOMAT AD.	KAÇAK AKIM KOR.	MON. OTOMAT AD.	KUTU ADEDİ	ADET TL
Z00982F	3x16 A 2 AD.	3x16 A 2 AD.	4x25 30mA 1AD.	1x16 A 1 AD.	2	10.758,00
Z00983F	3x25 A 2 AD.	3x25 A 2 AD.	4x25 30mA 1AD.	1x16 A 1 AD.	2	11.138,00
Z00984F	3x32 A 2 AD.	3x32 A 2 AD.	4x40 30mA 1AD.	1x16 A 1 AD.	2	12.510,00
Z00985F	4x16 A CEE 2 AD.	3x16 A 2 AD.	4x25 30mA 1AD.	1x16 A 1 AD.	2	11.720,00
Z00986F	4x32 A CEE 2 AD.	3x32 A 2 AD.	4x40 30mA 1AD.	1x16 A 1 AD.	2	12.685,00
Z00987F	3x16 A CEE 2 AD. 220 V	-	2x25 30mA 1AD.	1x16 A 1 AD.	2	6.880,00
Z00988F	3x32 A CEE 2 AD. 220 V	-	2x40 30mA 1AD.	1x16 A 1 AD. 1x32 A 2 AD.	2	9.858,00
Z00989F	5x16 A CEE 2 AD.	3x16 A 2 AD.	4x25 30mA 1AD.	1x16 A 1 AD.	2	11.562,00
Z00990F	5x32 A CEE 2 AD.	3x32 A 2 AD.	4x40 30mA 1AD.	1x16 A 1 AD.	2	13.132,00

250x330 Sinyalli Otomat Montajlı Hazır Kombinasyon

IP54



3 Ad. Makina Priz
2 Ad. 1x16 Pano Priz
Sinyal Lambalı

KOD	MAKİNE PRİZ AD.	TRF OTOMAT AD.	MON. OTOMAT AD.	KUTU ADEDİ	ADET TL
Z00901F	3x16 A Priz 3 AD.	3x16 A 3 AD.	1x16 A 1 AD.	2	7.760,00
Z00902F	3x25 A Priz 3 AD.	3x25 A 3 AD.	1x16 A 1 AD.	2	8.105,00
Z00903F	3x32 A Priz 3 AD.	3x32 A 3 AD.	1x16 A 1 AD.	2	8.855,00
Z00904F	3x16 A Priz CEE 3 AD. 220 V	-	1x16 A 4 AD.	2	4.485,00
Z00905F	3x32 A Priz CEE 3 AD. 220 V	-	1x16 A 1 AD. 1x32 A 3 AD.	2	5.430,00
Z00906F	4x16 A Priz CEE 3 AD.	3x16 A 3 AD.	1x16 A 1 AD.	2	8.415,00
Z00907F	4x32 A Priz CEE 3 AD.	3x32 A 3 AD.	1x16 A 1 AD.	2	8.965,00
Z00908F	5x16 A Priz CEE 3 AD.	3x16 A 3 AD.	1x16 A 1 AD.	2	8.605,00
Z00909F	5x32 A Priz CEE 3 AD.	3x32 A 3 AD.	1x16 A 1 AD.	2	9.485,00

250x330 Sinyalli Otomat Montajlı Hazır Kombinasyonlar

IP54



4 Ad. Makina Priz
4 Ad. 1x16 Pano Priz
Sinyal Lambalı

KOD	MAKİNE PRİZ AD.	TRF OTOMAT AD.	MON. OTOMAT AD.	KUTU ADEDİ	ADET TL
Z00701F	3x16 A Priz 4 AD.	3x25 A 2 AD.	1x16 A 2 AD.	2	6.510,00
Z00702F	3x25 A Priz 4 AD.	3x32 A 2 AD.	1x16 A 2 AD.	2	7.253,00
Z00703F	3x32 A Priz 4 AD.	3x32 A 2 AD.	1x16 A 2 AD.	2	7.395,00
Z00704F	3x16 A Priz CEE 4 AD. 220 V	-	1x16 A 6 AD.	2	5.235,00
Z00705F	3x32 A Priz CEE 4 AD. 220 V	-	1x16 A 2 AD. 1x32 A 4 AD.	2	5.465,00
Z00706F	4x16 A Priz CEE 4 AD.	3x25 A 2 AD.	1x16 A 2 AD.	2	7.310,00
Z00707F	4x32 A Priz CEE 4 AD.	3x32 A 2 AD.	1x16 A 2 AD.	2	7.932,00
Z00708F	5x16 A Priz CEE 4 AD.	3x25 A 2 AD.	1x16 A 2 AD.	2	7.525,00
Z00709F	5x32 A Priz CEE 4 AD.	3x32 A 2 AD.	1x16 A 2 AD.	2	8.195,00

250x500 Otomat Montajlı Hazır Arabalı Kombinasyonlar

IP54



4 Ad. Makina Priz
4 Ad. 1x16 Pano Priz
Sinyal Lambalı

KAÇAK AKIM KORUMALI

KOD	MAKİNE PRİZ AD.	TRF OTOMAT AD.	KAÇAK AKIM KOR.	MON. OTOMAT AD.	ADET TL
Z00751F	3x16 A Priz 4 AD.	3x16 A 4 AD.	4x25 30mA 1AD.	1x16 A 2 AD.	18.440,00
Z00752F	3x25 A Priz 4 AD.	3x25 A 4 AD.	4x25 30mA 1AD.	1x16 A 2 AD.	18.910,00
Z00753F	3x32 A Priz 4 AD.	3x32 A 4 AD.	4x40 30mA 1AD.	1x16 A 2 AD.	20.675,00
Z00758F	4x16 A Priz CEE 4 AD.	3x16 A 4 AD.	4x25 30mA 1AD.	1x16 A 2 AD.	19.930,00
Z00759F	4x32 A Priz CEE 4 AD.	3x32 A 4 AD.	4x40 30mA 1AD.	1x16 A 2 AD.	21.775,00
Z00754F	3x16 A Priz CEE 4 AD. 220V	-	2x25 30mA 1AD.	1x16 A 4 AD.	13.570,00
Z00755F	3x32 A Priz CEE 4 AD. 220 V	-	2x40 30mA 1AD.	1x16 A 4 AD. 1x32 A 4 AD.	17.207,00
Z00756F	5x16 A Priz CEE 4 AD.	3x16 A 4 AD.	4x25 30mA 1AD.	1x16 A 2 AD.	20.482,00
Z00757F	5x32 A Priz CEE 4 AD.	3x32 A 4 AD.	4x40 30mA 1AD.	1x16 A 2 AD.	22.225,00

Telefon Dağıtım Kutuları Mat Kapaklı Çatılı
IP55

Fiyatlara Kep Kep Dahil Değildir.

KOD	cinsi	KUTU AD.	ADET TL
Z00301F	10'lu Çatılı Telefon Kutusu 80x142x70	18	270,70
Z00302F	20'li Çatılı Telefon Kutusu 80x142x70	18	287,80
Z00303F	30'lu Çatılı Telefon Kutusu 110x180x68	8	297,80
Z00309F	40'lı Çatılı Telefon Kutusu 120x220x80	6	473,50
Z00304F	50'li Çatılı Telefon Kutusu 160x180x100	6	592,50
Z00305F	80'li Çatılı Telefon Kutusu 160x250x110	6	778,20
Z00306F	100'lü Çatılı Telefon Kutusu 180x270x100	3	1.016,50
Z00307F	160'lı Çatılı Telefon Kutusu 250x330x110	2	1.474,70
Z00308F	200'lü Çatılı Telefon Kutusu 250x330x110	2	1.575,60

Telefon Dağıtım Kutuları Mat Kapaklı Çatılı + Kep Kep'li
IP55



Fiyatlara Kep Kep Dahildir.

KOD	cinsi	KUTU AD.	ADET TL
Z00330F	10'lu Çatılı + Kep Kep'li Telefon Kutusu	18	389,70
Z00331F	20'li Çatılı + Kep Kep'li Telefon Kutusu	18	558,50
Z00332F	30'lu Çatılı + Kep Kep'li Telefon Kutusu	8	745,70
Z00338F	40'lı Çatılı + Kep Kep'li Telefon Kutusu	6	1.016,50
Z00333F	50'li Çatılı + Kep Kep'li Telefon Kutusu	6	1.337,00
Z00334F	80'li Çatılı + Kep Kep'li Telefon Kutusu	6	1.945,40
Z00335F	100'lü Çatılı + Kep Kep'li Telefon Kutusu	3	2.313,00
Z00336F	160'lı Çatılı + Kep Kep'li Telefon Kutusu	2	3.873,00
Z00337F	200'lü Çatılı + Kep Kep'li Telefon Kutusu	2	4.488,00

Telefon Dağıtım Kutuları Şeffaf Kapaklı Çatılı
IP55

 Fiyatlara Kep Kep Dahil Değildir.
Kırılmaz Polikarbonat Cam'dan Üretilmiştir.

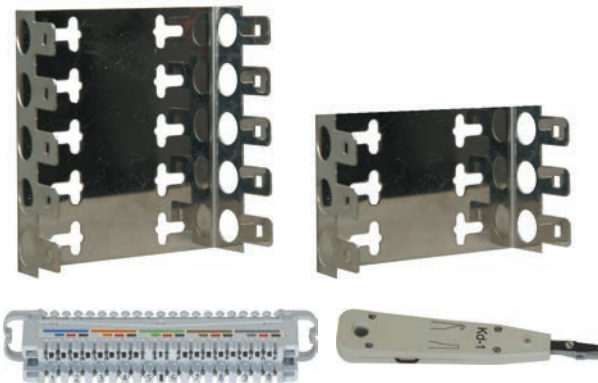
KOD	cinsi	KUTU AD.	ADET TL
Z00320F	10'lu Çatılı Telefon Kutusu 80x142x70	18	279,70
Z00321F	20'li Çatılı Telefon Kutusu 80x142x70	18	300,30
Z00322F	30'lu Çatılı Telefon Kutusu 110x180x68	8	318,80
Z00328F	40'lı Çatılı Telefon Kutusu 120x220x80	6	485,50
Z00323F	50'li Çatılı Telefon Kutusu 160x180x100	6	609,60
Z00324F	80'li Çatılı Telefon Kutusu 160x250x110	6	796,80
Z00325F	100'lü Çatılı Telefon Kutusu 180x270x100	3	1.033,80
Z00326F	160'lı Çatılı Telefon Kutusu 250x330x110	2	1520,10
Z00327F	200'lü Çatılı Telefon Kutusu 250x330x110	2	1.602,50

Telefon Çatıları

KOD	cinsi	KUTU AD.	ADET TL
Z00351F	10'lu Telefon Çatısı Krom	100	42,50
Z00352F	20'li Telefon Çatısı Krom	50	81,90
Z00353F	30'lu Telefon Çatısı Krom	50	132,60
Z00354F	50'li Telefon Çatısı Krom	30	212,10
Z00355F	80'li Telefon Çatısı Krom	20	332,30
Z00356F	100'lü Telefon Çatısı Krom	10	428,70
Z00357X	Kesmesiz Modül	10	171,20
Z00360X	Telefon İrtibatlama Aleti	10	603,50

Anahtar & Priz Kasaları



KOD	CİNSİ			KUTU AD.	ADET TL
Z00024F	Derin Kasa	Boru Geçmeli	Turuncu	100	15,60
Z00025F	Orta Boy Kasa	Boru Geçmeli	Turuncu	100	14,40
Z00027F	Derin Top. Priz Kasası	Boru Geçmeli	Turuncu	100	28,25
Z00026F	Derin Kasa Kapağı		Mavi	250	8,50
Z00029F	Orta Boy Kasa Kapağı		Mavi	250	8,50
Z00023F	1'li Alçıpan Kasa	60x51	Mavi	250	26,90
Z01502F	2'li Alçıpan Kasa	60x51	Mavi	100	73,55
Z01503F	3'lü Alçıpan Kasa	60x51	Mavi	100	64,90
Z01504F	4'lü Alçıpan Kasa	60x51	Mavi	100	113,90
Z01505F	5'li Alçıpan Kasa	60x51	Mavi	100	192,70
Z01506F	6'lı Alçıpan Kasa	60x51	Mavi	100	230,80
Z00028F	Alçıpan Kasa Montaj Kaması			100	4,96

Halogen Free Anahtar & Priz Kasaları



KOD	CİNSİ			KUTU AD.	ADET TL
Z01331F	Derin Kasa	Boru Geçmeli	H. Free	100	25,35
Z01330F	Orta Boy Kasa	Boru Geçmeli	Alev	100	22,00
Z01329F	Derin Top. Priz Kasası	Boru Geçmeli	Yaymaz	100	44,10
Z01328F	1'li Alçıpan Kasa	60x51		250	45,20
Z01332F	2'li Alçıpan Kasa	60x51		100	96,00
Z01333F	3'lü Alçıpan Kasa	60x51	H. Free	100	149,70
Z01334F	4'lü Alçıpan Kasa	60x51	Alev	100	180,50
Z01335F	5'li Alçıpan Kasa	60x51	Yaymaz	100	234,20
Z01336F	6'lı Alçıpan Kasa	60x51		100	290,50
Z01341F	Alçıpan Kasa Montaj Kaması			100	10,80

Sıva Altı Kare Buatlar & Lüks Kare Buat Kapakları



KOD	CİNSİ			KUTU AD.	ADET TL
Z01109F	S/A Q75 Buat	Kapaklı	[Q75x45]	36	52,40
Z01110F	S/A Q90 Buat	Kapaklı	[Q90x50]	26	67,30
Z01111F	S/A Kare Buat	Kapaklı	[85x85x50]	28	78,70
Z01112F	S/A Kare Buat	Kapaklı	[110x110x60]	18	211,70
Z01114F	S/A Kare Buat	Kapaklı	[160x180x70]	7	332,90
Z01115F	S/A Kare Buat	Kapaklı	[180x270x75]	3	544,50

KOD	CİNSİ			KUTU AD.	ADET TL
S00002F	Bombeli Lüks Buat Kapağı	Plastik Ayaklı		1000	13,20

S/A Zayıf Akım Buatı

KOD	cinsi	KUTU AD.	ADET TL
Z01116F	S/A Zayıf Akım Buatı 160x180	12	405,50

Tasarım Patentli Ürün
Sigorta Kutuları Sıva Altı

KOD	cinsi	KUTU AD.	ADET TL
Z00055F	1-2'li W Otomat Kutusu Sıva Üstü	38	65,75
Z00056F	3-5'li W Otomat Kutusu Sıva Üstü	12	125,80
Z00085F	9'lu W Otomat Kutusu Sıva Üstü	12	308,00
150009F	1-3'lü Otomat Kutusu (Pano Prizli) Etanj	15	386,00

Dış Mekan Otomat Kutusu
IP65

KOD	cinsi	KUTU AD.	ADET TL
A00056F	1-3'lü Dış Mekan Otomat Kutusu (Boş)	14	370,00

3 Adet W Otomat Takılabilir
Cam Kapaklı Nemliyer Sigorta Kutuları Sıva Üstü
IP55

KOD	cinsi	KUTU AD.	ADET TL
Z00059F	1-2'li W Otomat Kutusu Topraklama Klemensli	24	113,00
Z00060F	3-5'li W Otomat Kutusu Topraklama Klemensli	12	169,30
Z00090F	9'lu Mod. W Otomat Kutusu Topraklama Klemensli	12	421,00
Z00061F	13'lü Mod. W Otomat Kutusu Topraklama Klemensli	12	528,50
Z00091F	18'li [2 Ad. 9'lu Mod.] W Otomat Kutusu Topraklama Klm.	8	971,70
Z00092F	26'lı [2 Ad. 13'lü Mod.] W Otomat Kutusu Topraklama Klm.	1	1288,00
Z00093F	39'lu [3 Ad. 13'lü Mod.] W Otomat Kutusu Topraklama Klm.	1	1.985,00

Kırılmaz Polikarbonat Camdan Üretilmiştir.
Cam Kapaklı Nemliyer Sigorta Kutuları Sıva Altı
IP55

KOD	cinsi	KUTU AD.	ADET TL
Z00408F	1-2'li W Otomat Kutusu	24	113,00
Z00409F	3-5'li W Otomat Kutusu	12	169,25
Z00410F	9'lu Mod. W Otomat Kutusu Topraklama Klm. Turuncu Gövde	12	420,80
Z00411F	13'lü Mod. W Otomat Kutusu Topraklama Klm. Turuncu Gövde	12	528,50
Z00412F	18'li [2 Ad. 9'lu Mod.] W Otomat Kutusu Topraklama Klm. Turuncu Gövde	8	971,70
Z00413F	26'lı [2 Ad. 13'lü Mod.] W Otomat Kutusu Topraklama Klm. Turuncu Gövde	1	1288,00
Z00414F	39'lu [3 Ad. 13'lü Mod.] W Otomat Kutusu Topraklama Klm. Turuncu Gövde	1	1.985,00

ABS Gövdeli / Tasarım Patentli
Kırılmaz Polikarbonat Camdan Üretilmiştir.

Şeffaf Kapaklı Taban Saclı Perdeli Otomat Kutuları

IP55



KOD	cinsi			KUTU AD.	ADET TL
Z01421F	9'lu	1 Sıralı Dikey Sıva Üstü	180x270x100	3	1.184,00
Z01422F	14'lü	1 Sıralı Yatay Sıva Üstü	270x180x100	3	1.216,00
Z01423F	17'li	1 Sıralı Yatay Sıva Üstü	330x250x110	1	1.690,00
Z01424F	26'li	2 Sıralı Dikey Sıva Üstü	250x330x110	1	1.895,00
Z01426X	50'li	3 Sıralı Dikey Sıva Üstü	400x500x200	1	5.150,00
Z01427X	60'li	4 Sıralı Dikey Sıva Üstü	400x600x200	1	5.570,00

Mat Kapaklı Perde Saclı Otomat Kutuları

IP55



KOD	cinsi			KUTU AD.	ADET TL
Z01411F	9'lu	1 Sıralı Dikey Sıva Üstü	180x270x100	3	1.126,40
Z01412F	14'lü	1 Sıralı Yatay Sıva Üstü	270x180x100	3	1.152,00
Z01413F	17'li	1 Sıralı Yatay Sıva Üstü	330x250x110	1	1.675,00
Z01414F	26'li	2 Sıralı Dikey Sıva Üstü	250x330x110	1	1.805,00
Z01416X	50'li	3 Sıralı Dikey Sıva Üstü	400x500x200	1	4.370,00
Z01417X	60'li	4 Sıralı Dikey Sıva Üstü	400x600x200	1	4.590,00

Polyester Perde Saclı Alev Yaymaz Otomat Kutuları

IP55



KOD	cinsi			KUTU AD.	ADET TL
280166X	30x40x18 Perde Saclı	20 Otomat + Pako Şalter Kullanılabilir		1	6.174,00
280167X	40x50x19 Perde Saclı	45 Otomat + Pako Şalter Kullanılabilir		1	8.396,00
280168X	50x70x22 Perde Saclı	80 Otomat + Pako Şalter Kullanılabilir		1	15.103,00

Monoblok Gövde Perde Saclı

Çelik Spiraller

KOD	CİNSİ	PAKET MT.	METRE TL
152001X	9 mm	50	19,10
152002X	11 mm	50	21,65
152003X	14 mm	50	26,00
152009X	16 mm	50	29,90
152004X	18 mm	50	32,40
152034X	21 mm	50	37,55
152005X	26 mm	25	50,90
152000X	29 mm	25	56,60
152006X	37 mm	25	75,00
152007X	42 mm	25	86,60
152008X	50 mm	25	119,50

PVC Kaplı Spiraller

KOD	CİNSİ	PAKET MT.	METRE TL
152010X	9 mm	50	28,00
152011X	11 mm	50	29,30
152012X	14 mm	50	36,20
152026X	16 mm	50	40,05
152013X	18 mm	50	45,80
152028X	21 mm	50	53,40
152014X	26 mm	25	67,50
152027X	29 mm	25	74,20
152015X	37 mm	25	106,20
152016X	42 mm	25	127,20
152017X	50 mm	25	164,75

Polipropilen Spiral Hortum

KOD	CİNSİ	İÇ ÇAP	DIŞ ÇAP	PAKET METRE	METRE €
152121X	PG 9	10	13	100	0,45 €
152122X	PG 11	12	16	100	0,47 €
152123X	PG 13,5	14	18,5	50	0,65 €
152124X	PG 16	17	21,5	50	0,67 €
152125X	PG 21	23	28,7	50	0,99 €
152126X	PG 29	29	34,5	25	1,14 €
152127X	PG 36	36	42,5	25	1,50 €
152129X	PG 48	48	54,5	25	2,47 €

Polyamid Spiral Hortum

KOD	CİNSİ	İÇ ÇAP	DIŞ ÇAP	PAKET METRE	METRE €
152111X	PG 9	10	13	100	0,70 €
152112X	PG 11	12	16	100	0,92 €
152113X	PG 13,5	14	18,5	50	1,12 €
152114X	PG 16	17	21,5	50	1,37 €
152115X	PG 21	23	28,7	50	1,95 €
152116X	PG 29	29	34,5	25	2,47 €
152117X	PG 36	36	42,5	25	3,43 €
152119X	PG 48	48	54,5	25	4,78 €

PG Diş Geçmeli Spiral Rakorları Mevcuttur

PG Diş Geçmeli Spiral Rakorları Mevcuttur

İzoleli Çelik Takviyeli Sustalar 3,5 mm.Alman

KOD	CİNSİ	KUTU AD.	ADET TL
152051X	10 mt. Çelik Takviyeli Kolon Susta	15	431,00
152052X	15 mt. Çelik Takviyeli Kolon Susta	15	667,00
152053X	20 mt. Çelik Takviyeli Kolon Susta	10	884,00
152054X	25 mt. Çelik Takviyeli Kolon Susta	10	1.166,00

Ürün renk değişikliği gösterebilir

Çekme Kuvveti 300 Kg.

İzoleli Çelik Takviyeli Kolon Sustalar 4 mm.

KOD	CİNSİ	KUTU AD.	ADET TL
152021X	10 mt. Çelik Takviyeli Kolon Susta	15	586,80
152022X	15 mt. Çelik Takviyeli Kolon Susta	15	925,00
152023X	20 mt. Çelik Takviyeli Kolon Susta	10	1.266,00
152019X	25 mt. Çelik Takviyeli Kolon Susta	10	1.516,00
152020X	30 mt. Çelik Takviyeli Kolon Susta	10	1.825,00
152024X	50 mt. Çelik Takviyeli Kolon Susta	5	3.035,00

Ürün renk değişikliği gösterebilir

Çekme Kuvveti 350 Kg.

Etanj Rakorlar



KOD	ANMA ÖLÇÜSÜ	MONTAJ DELİĞİ	KABLO ALT VE ÜST ÖLÇÜ mm.	İÇİNDEN GEÇEBİLEN BAZI KABLolar			ANAHTAR ÖLÇÜSÜ	KUTU ADET	ADET TL
151009X	PG 7	13	3 - 6,5				15	700	10,40
151010X	PG 9	16	4 - 8				20	500	12,10
151001X	PG 11	19	5 - 10	1x16			23	300	14,00
151002X	PG 13,5	21	6 - 12	1x16	2x1,5	3x1,5	24	300	16,50
151003X	PG 16	23	10 - 14	1x25	2x4	3x2,5	26	200	19,00
151004X	PG 21	29	13 - 18	1x70	2x10	3x10	32	125	30,00
151005X	PG 29	38	18 - 25	1x150	2x25	3x16	42	60	54,40
151006X	PG 36	48	22 - 32	1x300	2x50	3x35	52	30	93,40
151007X	PG 42	55	30 - 38				60	24	115,00
151008X	PG 48	60	34 - 44				66	24	129,00

Kör Tapalar



KOD	CİNSİ		KUTU AD.	ADET TL
151021X	PG 7	Körtapa	250	4,99
151022X	PG 9	Körtapa	250	4,99
151023X	PG 11	Körtapa	250	4,99
151024X	PG 13,5	Körtapa	250	6,00
151025X	PG 16	Körtapa	250	7,26
151026X	PG 21	Körtapa	250	7,48
151027X	PG 29	Körtapa	150	17,00
151028X	PG 36	Körtapa	100	24,40

Kör Tapa Somunları

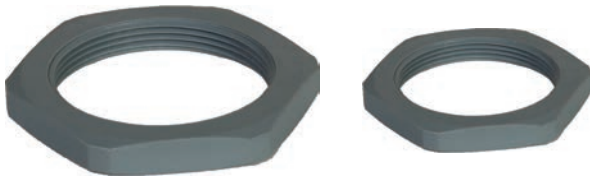

KOD	CİNSİ		KUTU AD.	ADET TL
151041X	PG 7	Somun	250	2,30
151042X	PG 9	Somun	250	2,37
151043X	PG 11	Somun	250	3,26
151044X	PG 13,5	Somun	250	3,85
151045X	PG 16	Somun	250	3,93
151046X	PG 21	Somun	250	5,19
151047X	PG 29	Somun	150	8,37
151048X	PG 36	Somun	100	18,67

Körüklü Rakorlar



KOD	CİNSİ		KUTU AD.	ADET TL
Z01451F	PG 7	Delik Çapı 13 mm	300	8,65
Z01452F	PG 9	Delik Çapı 16 mm	200	9,10
Z01453F	PG 11	Delik Çapı 19 mm	200	9,70
Z01454F	PG 13,5	Delik Çapı 21 mm	200	10,10
Z01455F	PG 16	Delik Çapı 23 mm	200	10,70
Z01456F	PG 21	Delik Çapı 29 mm	150	12,10
Z01457F	PG 29	Delik Çapı 38 mm	100	19,50

Eko Oval Armatürler E-27 Duylu**IP54**

X00094F



X00092F



X00091F



X00093F

KOD	CİNSİ	KUTU AD.	ADET TL
X00091F	Oval Düz Armatür [13W Tas. Ampul]	32	245,00
X00092F	Oval Mat Kafesli Armatür [13W Tas. Ampul]	32	287,00
X00093F	Oval Şeffaf Kfs. Armatür [13W Tas. Ampul]	32	312,00
X00094F	Oval Şapkalı Armatür [13W Tas. Ampul]	32	312,00

Gövde ve Cam Sararmayan, Darbeye Dayanıklı Polikarbonat hammaddesinden üretilmiştir

Eko Yuvarlak Armatürler E-27 Duylu**IP54**

X00095F



X00096F



X00097F

KOD	CİNSİ	KUTU AD.	ADET TL
X00095F	Yuvarlak Düz Armatür [13W Tas. Ampul]	30	296,00
X00096F	Yuvarlak Mat Kfs. Armatür [13W Tas. Ampul]	30	330,00
X00097F	Yuvarlak Şeffaf Kfs. Armatür [13W Tas. Ampul]	30	356,00

Gövde ve Cam Sararmayan, Darbeye Dayanıklı Polikarbonat hammaddesinden üretilmiştir

Etanj Nemliyer Oval Armatürler E-27 Duylu**IP65**

X00094F



X00092F



X00091F



X00093F

KOD	CİNSİ	KUTU AD.	ADET TL
X00025F	Oval Düz Armatür 60 W	32	312,00
X00024F	Oval Mat Kafesli Armatür 60 W	32	344,00
X00027F	Oval Şeffaf Kafesli Armatür 60 W	32	368,00
X00026F	Oval Şapkalı Armatür 60 W	32	368,00

Su ve Rutubete Karşı Korumalı, Camlar Contalıdır

Gövdeler İçi Metalize ve Prizmatik Kaplamalıdır

Gövde ve Cam Sararmayan, Darbeye Dayanıklı Polikarbonat hammaddesinden üretilmiştir

Etanj Nemliyer Yuvarlak Armatürler E-27 Duylu**IP65**

X00030F



X00031F



X00032F

KOD	CİNSİ	KUTU AD.	ADET TL
X00030F	Yuvarlak Düz Armatür 60 W	30	375,00
X00031F	Yuvarlak Mat Kafesli Armatür 60 W	30	414,00
X00032F	Yuvarlak Şeffaf Kafesli Armatür 60 W	30	451,00

Su ve Rutubete Karşı Korumalı, Camlar Contalıdır

Gövdeler İçi Metalize ve Prizmatik Kaplamalıdır

Gövde ve Cam Sararmayan, Darbeye Dayanıklı Polikarbonat hammaddesinden üretilmiştir

Ralina Duy

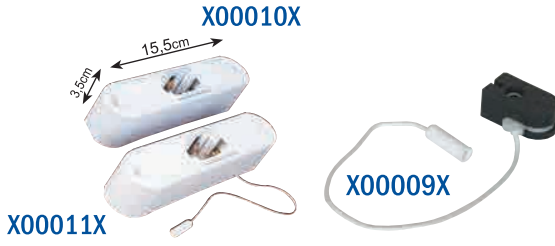

KOD	cinsi	KUTU AD.	ADET TL
X00010F	Düz Duy 15,5x3,5 cm	12	101,00
X00011F	İpli Switchli Duy 15,5x3,5 cm	12	194,00
X00009X	İpli Switchli	100	56,80

Gövde Polikarbonat Malzemedен Üretilmiştir.

Ralina Armatürler



KOD	cinsi	UZUNLUK	KUTU AD.	ADET TL
X00001F	35 W Düz	39 cm	25	233,00
X00002F	35 W İpli İtalyan Switchli	39 cm	25	316,00
X00003F	35 W Anahtarlı	39 cm	25	316,00
X00004F	60 W Düz	59 cm	25	256,00
X00005F	60 W İpli İtalyan Switchli	59 cm	25	375,00
X00006F	60 W Anahtarlı	59 cm	25	375,00

Gövde Polikarbonat Malzemedен Üretilmiştir.

Led'li Ralina Ampuller



KOD	cinsi	KUTU AD.	ADET \$
110001S	35 W Ralina Ampül Led	25	-
110002S	60 W Ralina Ampül Led	25	-

Renkli Dübeller

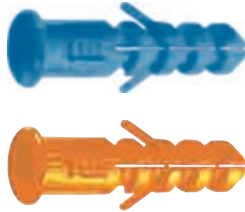

KOD	cinsi	KUTU AD.	ADET TL
Y00002F	7 mm [Turuncu]	5.000	0,54
Y00003F	8 mm [Mavi]	3.000	0,59
Y00004F	10 mm [Turuncu]	2.000	1,15

Vidalı Dübeller



KOD	cinsi	KUTU AD.	ADET TL
Y00022F	7 mm [Turuncu] Vidalı [25'li]	40	92,70
Y00023F	8 mm [Mavi] Vidalı [25'li]	30	105,50
Y00024F	10 mm [Turuncu] Vidalı [15'li]	25	157,00

Tij Takımları



Kablo Ölçüsü: 0,80 mm.

KOD	cinsi	KUTU AD.	ADET TL
150028F	Pors. Tij Takımı (Pls. Kılıflı) 75 W [Küçük Rozanslı]	60	55,60
150029F	Pors. Tij Takımı (Pls. Kılıflı) 75 W [Büyük Rozanslı]	50	60,00
150032F	Küçük Tij Rozansı	100	7,10
150031F	Büyük Tij Rozansı	100	12,60

Duylar

KOD	cinsi	KUTU AD.	ADET TL
X00044X	E 27 Polyamid Duy	100	-
X00040X	E 27 Universal Porselen Duy	105	22,50
X00041X	E 27 Universal Porselen Duy [Ayaklı]	90	38,00
X00043X	E 40 Universal Porselen Duy	24	215,00
X00171X	E 27 İtalyan Duy Somunlu [Siyah]	50	35,50
X00172X	E 27 İtalyan Duy Somunu	50	-
X00191X	E 14 İtalyan Duy Somunlu [Siyah]	100	32,00

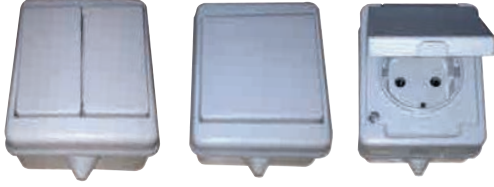
Beyaz renkli İtalyan duylara liste fiyatına +% 15 fiyat farkı uygulanır

Nemliyer Anahtar ve Prizler
IP55

KOD	cinsi	KUTU AD.	ADET TL
Z01241X	Anahtar Nemliyer	10	350,00
Z01242X	Komitatör Nemliyer	10	360,00
Z01243X	Vavien Nemliyer	10	350,00
Z01244X	Light Nemliyer	10	350,00
Z01245X	Kapaklı Topraklı Priz Nemliyer	10	400,00

Nemliyer Rotatif Tip Anahtar ve Prizler
IP55

KOD	cinsi	KUTU AD.	ADET TL
Z01235X	Anahtar Rotatif	12	492,00
Z01236X	Komitatör Rotatif	12	660,00
Z01237X	Kapaklı Topraklı Priz Rotatif	12	660,00
Z01238X	Vavien Rotatif	12	660,00



KOD	cinsi	KUTU AD.	ADET TL
Z01231X	Döküm Kapaklı Topraklı Priz	10	1.300,00

Büro Tipi Grup Priz Kanalları Boş

Yükseklik:55 En:62 mm
1 Modül= 45x22.5 mm
Eloksallı Alüminyum Gövde

KOD	CİNSİ		BOYUTLAR Yük. / En / Boy mm	KUTU AD.	ADET TL
Q00391F	2 Modül	45x22.5mm	55x62x135	1	284,70
Q00392F	4 Modül	45x22.5mm	55x62x180	1	382,00
Q00393F	6 Modül	45x22.5mm	55x62x225	1	456,70
Q00394F	8 Modül	45x22.5mm	55x62x270	1	540,00
Q00395F	10 Modül	45x22.5mm	55x62x315	1	632,00
Q00396F	12 Modül	45x22.5mm	55x62x360	1	696,80
Q00397F	14 Modül	45x22.5mm	55x62x405	1	784,00
Q00398F	16 Modül	45x22.5mm	55x62x450	1	845,00
Q00399F	18 Modül	45x22.5mm	55x62x495	1	933,00
Q00400F	20 Modül	45x22.5mm	55x62x540	1	1.015,00

Büro Tipi Grup Prizleri Dolu

Yükseklik:55 En:62 mm
1 Modül= 45x22.5 mm
Eloksallı Alüminyum Gövde

HDMI - USB - VGA İçin
Fiyat Sorunuz

KOD	CİNSİ		BOYUTLAR Yük. / En / Boy mm	KUTU AD.	ADET TL
Q00311F	2 Modül	45x22.5mm	55x62x135	1	616,00
Q00312F	4 Modül	45x22.5mm	55x62x180	1	831,00
Q00313F	6 Modül	45x22.5mm	55x62x225	1	1.037,00
Q00314F	8 Modül	45x22.5mm	55x62x270	1	1.250,00
Q00315F	10 Modül	45x22.5mm	55x62x315	1	1.646,00
Q00316F	12 Modül	45x22.5mm	55x62x360	1	1.827,00
Q00317F	14 Modül	45x22.5mm	55x62x405	1	1.964,00
Q00318F	16 Modül	45x22.5mm	55x62x450	1	2.338,00
Q00319F	18 Modül	45x22.5mm	55x62x495	1	2.680,00
Q00320F	20 Modül	45x22.5mm	55x62x540	1	2.904,00

Sigortalı Büro Tipi Grup Prizleri Dolu

Yükseklik:55 En:62 mm
1 Modül= 45x22.5 mm
Eloksallı Alüminyum Gövde

KOD	CİNSİ		BOYUTLAR Yük. / En / Boy mm	KUTU AD.	ADET TL
Q00331F	2 Modül	45x22.5mm	55x62x245	1	1.385,00
Q00332F	4 Modül	45x22.5mm	55x62x290	1	1.614,00
Q00333F	6 Modül	45x22.5mm	55x62x335	1	1.820,00
Q00334F	8 Modül	45x22.5mm	55x62x380	1	2.066,00
Q00335F	10 Modül	45x22.5mm	55x62x425	1	2.405,00
Q00336F	12 Modül	45x22.5mm	55x62x470	1	2.588,00
Q00337F	14 Modül	45x22.5mm	55x62x515	1	2.803,00
Q00338F	16 Modül	45x22.5mm	55x62x560	1	3.027,00
Q00339F	18 Modül	45x22.5mm	55x62x605	1	3.411,00
Q00340F	20 Modül	45x22.5mm	55x62x650	1	3.700,00

Grup Priz Kanalları

Yükseklik:55 En:62 mm
Renk: Eloksallı Gri

KOD	CİNSİ		KUTU AD.	ADET TL
R00111F	55x62x1 mt		1	1.910,00
R00112F	55x62x2 mt		1	3.770,00
R00113F	55x62x3 mt		1	5.860,00

Pano - Seyyar Tip Midi Boş Grup Priz Kanalları



Yükseklik: 45 En:50 mm
1 Modül = 45x22.5 mm
Eloksallı Alüminyum Gövde

KOD	cinsi	BOYUTLAR Yük. / En / Boy mm	KUTU AD.	ADET TL
Q00351F	2 Modül 45x22.5mm	45x50x125	1	262,00
Q00352F	4 Modül 45x22.5mm	45x50x170	1	333,00
Q00353F	6 Modül 45x22.5mm	45x50x215	1	399,00
Q00354F	8 Modül 45x22.5mm	45x50x260	1	470,00
Q00355F	10 Modül 45x22.5mm	45x50x305	1	567,40
Q00356F	12 Modül 45x22.5mm	45x50x350	1	650,00
Q00357F	14 Modül 45x22.5mm	45x50x395	1	699,90
Q00358F	16 Modül 45x22.5mm	45x50x440	1	752,00
Q00359F	18 Modül 45x22.5mm	45x50x485	1	827,00
Q00360F	20 Modül 45x22.5mm	45x50x530	1	892,00

Pano - Seyyar Tip Midi Dolu Grup Priz Kanalları



Yükseklik: 45 En:50 mm
1 Modül = 45x22.5 mm
Eloksallı Alüminyum Gövde

HDMI - USB - VGA İçin
Fiyat Sorunuz

KOD	cinsi	BOYUTLAR Yük. / En / Boy mm	KUTU AD.	ADET TL
Q00361F	2 Modül 45x22.5mm	45x50x125	1	553,00
Q00362F	4 Modül 45x22.5mm	45x50x170	1	650,00
Q00363F	6 Modül 45x22.5mm	45x50x215	1	833,00
Q00364F	8 Modül 45x22.5mm	45x50x260	1	1.045,00
Q00365F	10 Modül 45x22.5mm	45x50x305	1	1.264,00
Q00366F	12 Modül 45x22.5mm	45x50x350	1	1.448,00
Q00367F	14 Modül 45x22.5mm	45x50x395	1	1.657,00
Q00368F	16 Modül 45x22.5mm	45x50x440	1	1.840,00
Q00369F	18 Modül 45x22.5mm	45x50x485	1	2.058,00
Q00370F	20 Modül 45x22.5mm	45x50x530	1	2.244,00

Pano - Seyyar Tip Midi Sigortalı Dolu Grup Priz Kanalları



Yükseklik: 45 En:50 mm
1 Modül = 45x22.5 mm
Eloksallı Alüminyum Gövde

KOD	cinsi	BOYUTLAR Yük. / En / Boy mm	KUTU AD.	ADET TL
Q00371F	2 Modül 45x22.5mm	45x50x235	1	1.196,00
Q00372F	4 Modül 45x22.5mm	45x50x280	1	1.389,00
Q00373F	6 Modül 45x22.5mm	45x50x325	1	1.570,00
Q00374F	8 Modül 45x22.5mm	45x50x370	1	1.780,00
Q00375F	10 Modül 45x22.5mm	45x50x415	1	1.988,00
Q00376F	12 Modül 45x22.5mm	45x50x460	1	2.174,00
Q00377F	14 Modül 45x22.5mm	45x50x505	1	2.364,00
Q00378F	16 Modül 45x22.5mm	45x50x550	1	2.550,00
Q00379F	18 Modül 45x22.5mm	45x50x595	1	2.760,00
Q00380F	20 Modül 45x22.5mm	45x50x640	1	3.033,00

Grup Priz Kanalları



Yükseklik:45 En: 50 mm
Renk: Eloksallı Gri

KOD	cinsi	KUTU AD.	ADET TL
R00121F	45x50x1 mt	1	1.717,00
R00122F	45x50x2 mt	1	3.394,00
R00123F	45x50x3 mt	1	5.261,00

110 °C Isıya Dayanıklı Plastik Sıra Klemensler Mavi

İç: MS 58 Pirinç ve Nikel Kaplamalı

KOD	CİNSİ			AKIM [A]	KUTU AD.	ADET TL
G00001F	No:1	2.5-4 mm ²	12 Sıra	32	50	69,70
G00002F	No:2	4-6 mm ²	12 Sıra	41	50	89,30
G00003F	No:3	6-10 mm ²	10 Sıra	57	50	93,80
G00004F	No:4	10-16 mm ²	6 Sıra	76	50	94,90
G00005F	No:5	16-25 mm ²	6 Sıra	101	50	108,70
G00019F	No:6	25-35 mm ²	6 Sıra	125	50	189,50
G00020F	No:7	35-50 mm ²	6 Sıra	160	50	239,10

160 °C Isıya Dayanıklı Polyamid Sıra Klemensler Kırmızı

İç: MS 58 Pirinç ve Nikel Kaplamalı

KOD	CİNSİ			AKIM [A]	KUTU AD.	ADET TL
G00006F	No:1	2.5-4 mm ²	12 Sıra	32	50	73,70
G00007F	No:2	4-6 mm ²	12 Sıra	41	50	95,30
G00008F	No:3	6-10 mm ²	10 Sıra	57	50	103,20
G00009F	No:4	10-16 mm ²	6 Sıra	76	50	104,10
G00013F	No:5	16-25 mm ²	6 Sıra	101	50	121,90
G00014F	No:6	25-35 mm ²	6 Sıra	125	50	194,10
G00022F	No:7	35-50 mm ²	6 Sıra	160	50	240,20

Pano İçİ Yüksek Isıya Dayanıklı Klemensler 200 °C VO Gri

İç: MS 58 Pirinç ve Nikel Kaplamalı
RoHS Kriterlerine Uygun

Halogen Free Alev Yaymaz

KOD	CİNSİ			AKIM [A]	KUTU AD.	ADET TL
G00024F	No:1	2.5-4 mm ²	12 Sıra	32	50	82,90
G00025F	No:2	4-6 mm ²	12 Sıra	41	50	108,50
G00026F	No:3	6-10 mm ²	10 Sıra	57	50	122,00
G00027F	No:4	10-16 mm ²	6 Sıra	76	50	122,90
G00028F	No:5	16-25 mm ²	6 Sıra	101	50	144,80
G00029F	No:6	25-35 mm ²	6 Sıra	125	50	212,80
G00030F	No:7	35-50 mm ²	6 Sıra	160	50	268,70

110 °C Isıya Dayanıklı Plastik Sıra Klemensler Beyaz

İç: MS 58 Pirinç ve Nikel Kaplamalı

KOD	CİNSİ			AKIM [A]	KUTU AD.	ADET TL
G00035F	No:1	2.5-4 mm ²	12 Sıra	32	50	69,70
G00036F	No:2	4-6 mm ²	12 Sıra	41	50	89,30
G00034F	No:3	6-10 mm ²	10 Sıra	57	50	93,80

160 °C Isıya Dayanıklı Polyamid Sıra Klemensler Beyaz

İç: MS 58 Pirinç ve Nikel Kaplamalı

KOD	CİNSİ			AKIM [A]	KUTU AD.	ADET TL
G00037F	No:1	2.5-4 mm ²	12 Sıra	32	50	73,70
G00038F	No:2	4-6 mm ²	12 Sıra	41	50	95,30
G00039F	No:3	6-10 mm ²	10 Sıra	57	50	103,20

170 °C Isıya Dayanıklı Şeffaf Polikarbonat Klemensler

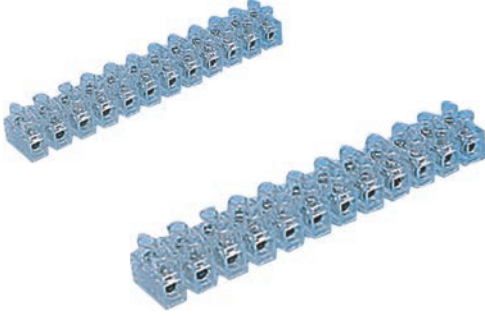

KOD	cinsi		AKIM (A)	KUTU AD.	ADET TL
G00010F	No:1	2.5-4 mm ² 12 Sıra	32	50	78,80
G00011F	No:2	4-6 mm ² 12 Sıra	41	50	102,90
G00012F	No:3	6-10 mm ² 10 Sıra	57	50	111,70

İç: MS 58 Pirinç ve Nikel Kaplamalı

170 °C Isıya Dayanıklı Polikarbonat Buat Klemensler

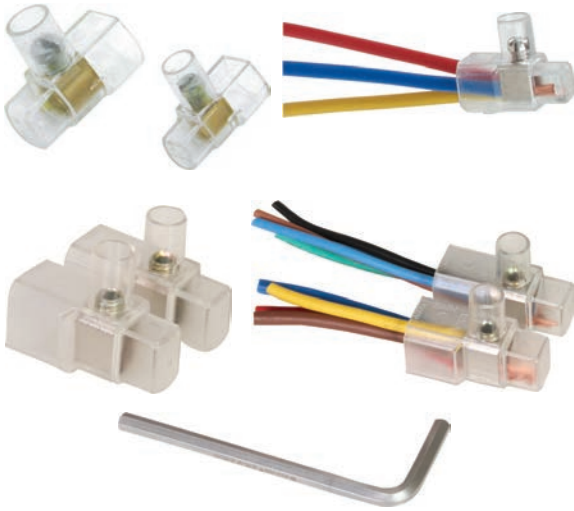

KOD	cinsi		AKIM (A)	KUTU AD.	ADET TL
J00010F	No:2 Buat Klemensi	4-6 mm ²	41	588	6,15
J00011F	No:3 Buat Klemensi	6-16 mm ²	57	432	7,80
J00012F	No:4 Buat Klemensi	16-25 mm ²	76	240	10,25
J00013F	No:5 Buat Klemensi	25-35 mm ²	101	200	15,25
J00014F	No:6 Buat Klemensi	35-50 mm ²	125	120	29,15
J00015F	No:7 Buat Klemensi	50-70 mm ²	125	160	67,80
J00016F	No:8 Buat Klemensi	95-120 mm ²	160	120	96,50

No: 7 ve 8 Buat Klemens Vidaları Alyan Başlıdır

İç: MS 58 Pirinç ve Nikel Kaplamalı

1.5 kV Porselen Klemensler



KOD	cinsi		AKIM (A)	KUTU AD.	ADET TL
K00002F	No: 1-2'li	2.5-4 mm ²	32	180	27,20
K00003F	No: 1-3'lü	2.5-4 mm ²	32	90	38,30
K00004F	No: 2-2'li	4-6 mm ²	41	128	33,10
K00006F	No: 2-3'lü	4-6 mm ²	41	64	45,75
K00005F	No: 3-2'li	6-10 mm ²	57	54	55,60
K00007F	No: 3-3'lü	6-10 mm ²	57	30	78,40
K00009F	No: 4-2'li	10-16 mm ²		30	117,75
K00011F	No: 6-2'li	25-35 mm ²		30	161,55

İç: MS 58 Pirinç ve Nikel Kaplamalı

Metal Gövdeli Nihayet Şalterleri

W00011X



W00009X



W00021X



W00008X



W00015X



W00010X

KOD	CİNSİ	KUTU AD.	ADET TL
W00008X	Spiral Telli	10	1.920,00
W00010X	Metal Pimli	10	1.587,00
W00009X	Metal Pimli Rulmanlı	10	1.722,00
W00021X	Tek Yönde Yatay Rulmanlı	10	1.968,00
W00015X	Çift Yönde Yatay Rulmanlı	10	1.968,00
W00011X	Kontakt Bloğu	10	666,00

Plastik Gövdeli Nihayet Şalterleri

W00028X



W00025X



W00027X



W00026X



W00029X

KOD	CİNSİ	KUTU AD.	ADET TL
W00025X	Metal Pimli	10	1.238,00
W00026X	Pimli Makaralı	10	1.238,00
W00027X	Tek Yönde Yatay	10	1.380,00
W00028X	Çift Yönde Yatay Ayarlı	10	1.380,00
W00029X	Çift Yönde Yatay	10	1.380,00

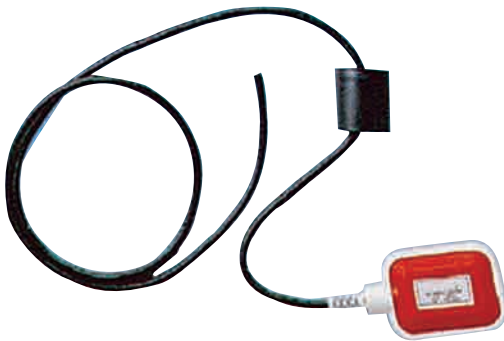
Su Seviye Şalterleri

KOD	CİNSİ	KUTU AD.	ADET TL
W00031X	1.5 mt Switchli - Monofaze	20	1.293,00
W00033X	3 mt Switchli - Monofaze	20	1.587,00
W00035X	5 mt Switchli - Monofaze	20	1.825,00
W00036X	10 mt Switchli - Monofaze	10	2.611,00
W00038X	15 mt Switchli - Monofaze	10	3.404,00

Direkt Termik Manyetik Şalterleri



Reset Düğmeli

KOD	kW	AMPER SAHASI 380 V	KUTU AD.	ADET TL
A00001F	0.18 kW	0.40 - 0.63	1	4.030,00
A00002F	0.25 kW	0.63 - 1.0	1	4.030,00
A00004F	0.55 kW	1.2 - 1.8	1	4.030,00
A00005F	0.75 kW	1.6 - 2.5	1	4.030,00
A00007F	1.5 kW	2.5 - 4	1	4.030,00
A00008F	2.2 kW	4 - 6	1	4.191,00
A00009F	3 kW	5.5 - 8	1	4.191,00
A00010F	4 kW	7 - 10	1	4.191,00
A00011F	5.5 kW	9 - 13	1	4.364,00
A00012F	7.5 kW	12 - 18	1	4.664,00
A00013F	10 kW	16 - 24	1	5.079,00

Endirekt Termik Manyetik Şalterleri



Reset Düğmeli

KOD	kW	AMPER SAHASI 380 V	KUTU AD.	ADET TL
A00014F	0.18 kW	0.40 - 0.63	1	4.193,00
A00015F	0.25 kW	0.63 - 1.0	1	4.193,00
A00017F	0.55 kW	1.2 - 1.8	1	4.193,00
A00018F	0.75 kW	1.6 - 2.5	1	4.193,00
A00020F	1.5 kW	2.5 - 4	1	4.193,00
A00021F	2.2 kW	4 - 6	1	4.350,00
A00022F	3 kW	5.5 - 8	1	4.350,00
A00023F	4 kW	7 - 10	1	4.350,00
A00024F	5.5 kW	9 - 13	1	4.553,00
A00025F	7.5 kW	12 - 18	1	4.850,00
A00026F	10 kW	16 - 24	1	5.254,00

Kutulu Motor Koruma Şalterleri

IP65



KOD	kW	AMPER SAHASI 380 V		KUTU AD.	ADET TL
A00043F	0.18 kW	0.40 - 0.63	Termik Manyetik	1	2.798,00
A00044F	0.25 kW	0.63 - 1.00	Termik Manyetik	1	2.798,00
A00045F	0.55 kW	1.00 - 1.60	Termik Manyetik	1	2.798,00
A00046F	1.1 kW	1.60 - 2.50	Termik Manyetik	1	2.798,00
A00047F	1.5 kW	2.50 - 4.00	Termik Manyetik	1	2.798,00
A00048F	2.2 kW	4.00 - 6.30	Termik Manyetik	1	2.798,00
A00049F	4 kW	6.30 - 10.00	Termik Manyetik	1	2.798,00
A00050F	5 kW	9.00 - 14.00	Termik Manyetik	1	2.798,00
A00052F	7.5 kW	13.00 - 18.00	Termik Manyetik	1	2.798,00
A00053F	9 kW	17.00 - 23.00	Termik Manyetik	1	2.798,00
A00054F	11 kW	20.00 - 25.00	Termik Manyetik	1	2.798,00
A00055F	15 kW	24.00 - 32.00	Termik Manyetik	1	2.798,00

KOD	cinsi	KUTU AD.	ADET TL
A00056F	Motor Koruma Şalter Kutusu	14	370,00
A00058X	Yardımcı Kontak Bloğu	10	446,00

Bimetalik Al-Cu Klemensler

		KOD	CİVATA ADET	CİNSİ	SIKMA SAHASI mm ²	ALM. İLETKEN	BOYUTLAR mm.	KUTU ADET	ADET TL
A25 B16		B00021F	1	A25 B16	6-25 Al/2.5-16 Cu	Ø 4-7,5	Rose, Lily, Swallow	100	60,20
		B00022F	1	A40 B25	16-40Al/10-25 Cu	Ø 5-10	Rose, Lily, Swallow, Sparrow, Rabinone, Pansy, Poppy	100	77,30
A40 B25		B00023F	2	A70 B50	16-70Al/10-50 Cu	Ø 5-10	Rose, Lily, Swallow, Sparrow, Rabinone, Pansy, Poppy	50	132,40
		B00038F	2	A70 B95	16-70Al/50-95 Cu	Ø 5-10	Rose, Lily, Swallow, Sparrow, Rabinone, Pansy, Poppy	50	204,70
A70 B50		B00039F	3	A70 B120	16-70Al/50-120 Cu	Ø 5-10	Rose, Lily, Swallow, Sparrow, Rabinone, Pansy, Poppy	50	227,00
		B00034F	1	A120 B25	70-120Al/10-25Cu	Ø 7-13	Aster, Phlox, Rabinone, Oxlip, Raven, Pigeon, Poppy	100	89,40
A120 B50		B00036F	2	A120 B50	70-120Al/10-50Cu	Ø 7-13	Aster, Phlox, Rabinone, Oxlip, Raven, Pigeon, Poppy	50	195,00
		B00024F	3	A120 B70	70-120Al/10-70Cu	Ø 7-13	Aster, Phlox, Rabinone, Oxlip, Raven, Pigeon, Poppy	50	223,00
A120 B70		B00083F	3	A120 B95	70-120Al/50-95Cu	Ø 7-13	Aster, Phlox, Rabinone, Oxlip, Raven, Pigeon, Poppy	50	247,50
		B00041F	3	A120 B120	70-120Al/50-120Cu	Ø 7-13	Aster, Phlox, Rabinone, Oxlip, Raven, Pigeon, Poppy	50	270,40
A240 B120		B00025F	3	A240 B120	70-240Al/50-120Cu	Ø 11-22	Daisy, Peony, Tulip, Canna, Phlox, Oxlip, Partridge, Ostrich, Hawk, Pigeon	25	447,60
		B00037F	3	A240 B240	70-240Al/70-240Cu	Ø 11-22	Daisy, Peony, Tulip, Canna, Phlox, Oxlip, Partridge, Ostrich, Hawk, Pigeon	25	602,00

Alüminyum Paralel Klemensler (Branşman-Atlama)

		KOD	CİVATA ADET	CİNSİ	SIKMA SAHASI mm ²	ALM. İLETKEN Ø	BOYUTLAR mm.	KUTU ADET	ADET TL
A25 A25		B00026F	1	A16 A16	6----16	Ø 3-6,5	Rose	100	31,90
A40 A40		B00027F	1	A25 A25	6----25	Ø 4-7,5	Rose, Lily, Swallow	100	36,70
A70 A70		B00028F	1	A40 A40	16----40	Ø 5-10	Rose, Lily, Swallow, Sparrow, Rabinone, Pansy, Poppy	100	51,20
		B00029F	2	A70 A70	16----70	Ø 5-10	Rose, Lily, Swallow, Sparrow, Rabinone, Pansy, Poppy	50	91,00
A95 A95		B00086F	2	A95 A95	25----95	Ø 6-12	Lily, Pansy, Swallow, Rabinone, Aster, Rawen, Sparrow, Poppy, Phlox	50	99,90
A120 A120		B00030F	3	A120 A120	40----120	Ø 7-13	Aster, Phlox, Rabinone, Pigeon Oxlip, Raven, Poppy	50	143,80
A150 A150		B00088F	3	A150 A150	40----150	Ø 6-16	Aster, Phlox, Oxlip, Rabinone, Daisy, Raven, Partridge, Pigeon, Peony, Poppy	25	193,90
		B00042F	3	A240 A120	70----240 50----120	Ø 11-22	Daisy, Peony, Tulip, Canna, Phlox, Partridge, Ostrich, Hawk, Pigeon, Oxlip	25	292,80
A240 A240		B00031F	3	A240 A240	70----240	Ø 11-22	Daisy, Peony, Tulip, Canna, Phlox, Partridge, Ostrich, Hawk, Pigeon, Oxlip	25	344,30

Durdurucu Klemensler

		KOD	CİVATA ADET	CİNSİ	SIKMA SAHASI mm ²	ALM. İLETKEN Ø	Kullanacağı İletkenler	KUTU ADET	ADET TL
A16 A50		B00032F	2	A16 A50	16----50	Ø 4-9,5	Rose, Lily, Swallow, Pansy, Sparrow, Rabinone, Poppy	100	92,60
A50 A95		B00033F	3	A50 A95	50----95	Ø 5-12,5	Lily, Phlox, Aster, Poppy, Pigeon, Sparrow, Swallow, Rawen, Rabinone,	50	146,00
A95 A120		B00090F	3	A95 A120	95----120	Ø 7-13,5	Rabinone, Rawen, Pigeon, Oxlip, Phlox, Aster, Poppy	50	172,00

Alüminyum Klemens Kılıfları

KOD	CİNSİ	SIKMA SAHASI mm ²	KUTU AD.	ADET TL
B00018F	Pak 70 Alüminyum Klemens Kılıfı	50----70	100	37,50
B00170X	Sarı Macun 250 gr		10	2.285,00

Alüminyum Bükme Ek Borular



KOD	cinsi	KUTU ADET	ADET TL
B00351F	FAB-25 - 35 mm ² İletken [Rose-Swan]	290	25 64,50
B00352F	FAB-40 - 50 mm ² İletken [Lily-Pansy-Swallow-Sparrow]	370	25 89,90
B00353F	FAB-63 - 70 mm ² İletken [Poppy-Aster-Rabibone]	470	25 120,25
B00354F	FAB-99 - 95 mm ² İletken [Pholx-Raven]	620	25 235,50

Aski Klemensi



KOD	cinsi	KUTU ADET	ADET TL
B00091F	Aski Klemensi Kulaklı	50	242,50
B00092X	Aski Kancası 100 mm	50	114,50

Takoz ve Top Başı Alüminyum Klemensler

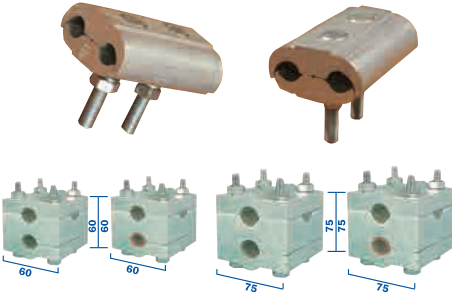

KOD	KABLO TİPİ	KULLANILAN İLETKENLER	KUTU ADET	ADET TL
B00040F	266,8	Partidge / Daisy / Ostich	25	377,90
KOD	cinsi	KUTU ADET	ADET TL	
B00043F	Al - Al Hawk Ø 21x21 T 60x60	10	634,00	
B00044F	Al - Cu Hawk Ø 21x21 T 60x60	10	758,00	
B00045F	Al - Al Hawk Ø 21x21 T 75x75	10	999,00	
B00046F	Al - Cu Hawk Ø 21x21 T 75x75	10	1.149,00	

Özel Klemensler

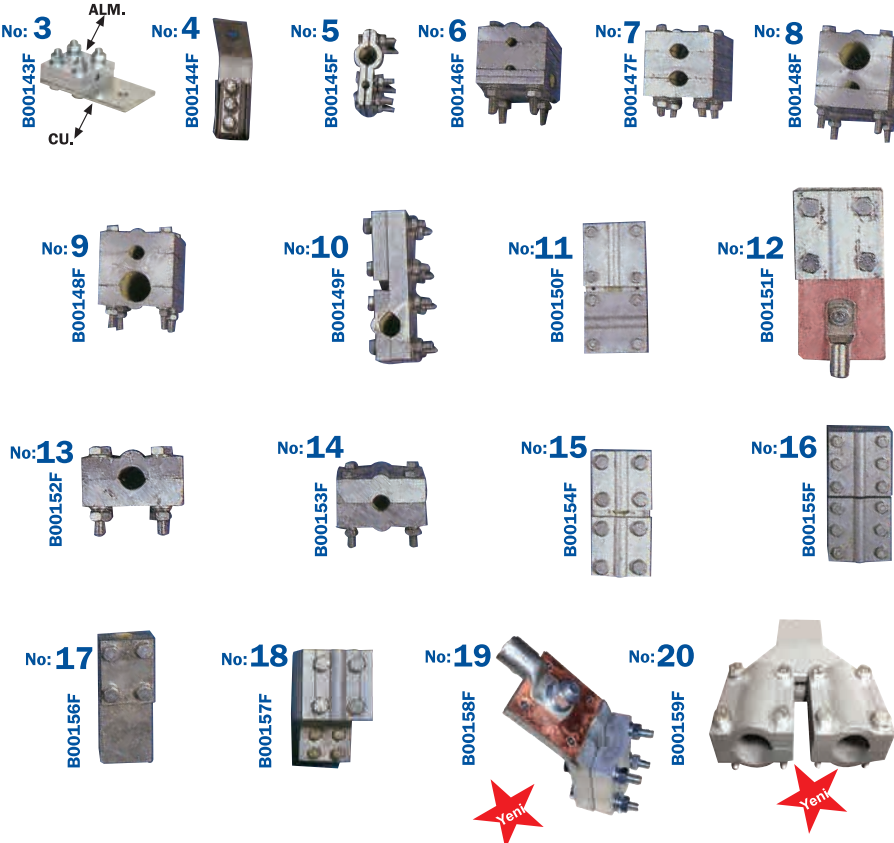

- 3- Swallow, Raven, Pigeon Alm. İletkenlerden Yeraltına Geçişlerde
- 4- Harici Tip Trafo Geçiş Klemensi
- 5- 1/0 İletken ile Branş Alma Klemensi
- 6- Ø 12x28 Küp [Takoz] Klemens
- 7- Ø 21x28 Küp [Takoz] Klemens
- 8/9- Ø 21x41 Küp [Takoz] Klemens
- 10- Ø 21x28 T Klemens
- 11- Ø 21x41 T Klemens
- 12- Alüminyum İletkenden Yeraltı Kablosuna Geçişte Kullanılır
- 13- 80x5 veya 80x10 Alüminyum Baraya İletkenin Doğrudan İrtibatlanmasında Kullanılır
- 14- 10x10 Alüminyum Baraya İletkenin Doğrudan İrtibatlanmasında Kullanılır
- 15- Al/G İletken Çapı (Ø21-Ø28) ve Geçit İzalatör, Çapı (Ø21-Ø28) olan Geçit İzalatörlerinde Kullanılır
- 16- Al/G İletken Çapı (Ø21-Ø41) olan Geçit İzalatörlerinde Kullanılır
- 17- Bara Papucu
- 18- AL/CU Seksiyoner Giriş ve Çıkışın Daha Sağlam Olması İçin Kullanılır
- 19- Eğik Alüminyum İletkenden Yeraltı Kablosuna Geçişte Kullanılır
- 20- Çatal Uçlu

Özel Klemenslerin Fiyatı Sipariş Anında Bildirilecektir

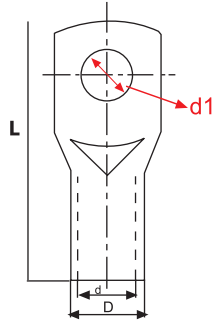
TSE NORM Standart Tip Bakır Sıkmalı Kablo Papucu [SKP]

KOD	cİnsi	çİVATA d1	İÇ ÇAP d	DIŞ ÇAP D	UZUNLUK L	KUTU ADET	ADET TL
C00001F	6'lik	M6	3.8	5.2	25.5	1000	17,65
C00301F	6'lik	M5	3.8	5.2	25.5	1000	17,65
C00002F	10'luk	M6	4.5	5.7	30.5	800	18,45
C00302F	10'luk	M8	4.5	5.7	30.5	800	18,45
C00003F	16'lik	M6	5.7	7.8	34.5	400	27,45
C00303F	16'lik	M8	5.7	7.8	34.5	400	27,45
C00004F	25'lik	M8	7	9	39.5	300	39,80
C00304F	25'lik	M10	7	9	39.5	300	39,80
C00005F	35'lik	M8	8.2	10.8	44.5	200	58,65
C00305F	35'lik	M10	8.2	10.8	44.5	200	58,65
C00006F	50'lik	M10	10	12.5	51	150	86,20
C00306F	50'lik	M12	10	12.5	51	150	86,20
C00007F	70'lik	M10	11.5	14.5	55.5	100	114,00
C00307F	70'lik	M12	11.5	14.5	55.5	100	114,00
C00008F	95'lik	M12	13.5	16.5	59.5	60	142,60
C00308F	95'lik	M10	13.5	16.5	59.5	60	142,60
C00009F	120'lik	M12	15.5	19	65.5	50	199,70
C00309F	120'lik	M10	15.5	19	65.5	50	199,70
C00010F	150'lik	M12	17	21	74.5	40	313,40
C00310F	150'lik	M14	17	21	74.5	40	313,40
C00011F	185'lik	M16	19	23.5	83	30	388,50
C00311F	185'lik	M14	19	23.5	83	30	388,50
C00012F	240'lik	M16	21.5	26	89	24	515,00
C00312F	240'lik	M14	21.5	26	89	24	515,00
C00013F	300'lük	M16	24.5	29	97	15	599,50
C00313F	300'lük	M14	24.5	29	97	15	599,50
C00014F	400'lük	M20	27.5	33	112	8	757,00
C00314F	400'lük	M16	27.5	33	112	8	757,00
C00015F	500'lük	M20	31	37	121	8	1.496,00
C00315F	500'lük	M16	31	37	121	8	1.496,00
C00016F	625'lik	M20	34.5	41	134	6	2.476,00
C00316F	625'lik	M16	34.5	41	134	6	2.476,00

Standart Tip Isıyla Daralan SKP Kılıfları

KOD	cİnsi	KUTU AD.	ADET TL
C00101X	6'lik Kılıf	1000	
C00102X	10'luk Kılıf	800	
C00103X	16'lik Kılıf	400	
C00104X	25'lik Kılıf	200	
C00105X	35'lik Kılıf	200	
C00106X	50'lik Kılıf	200	
C00107X	70'lik Kılıf	100	
C00108X	95'lik Kılıf	40	
C00109X	120'lik Kılıf	40	
C00110X	150'lik Kılıf	40	
C00111X	185'lik Kılıf	40	
C00112X	240'lik Kılıf	40	
C00113X	300'lük Kılıf	20	
C00114X	400'lük Kılıf	20	
C00115X	500'lük Kılıf	20	
C00116X	625'lik Kılıf	20	

Bakır Sıkmalı Kablo Papucu (SKP) DIN 46235

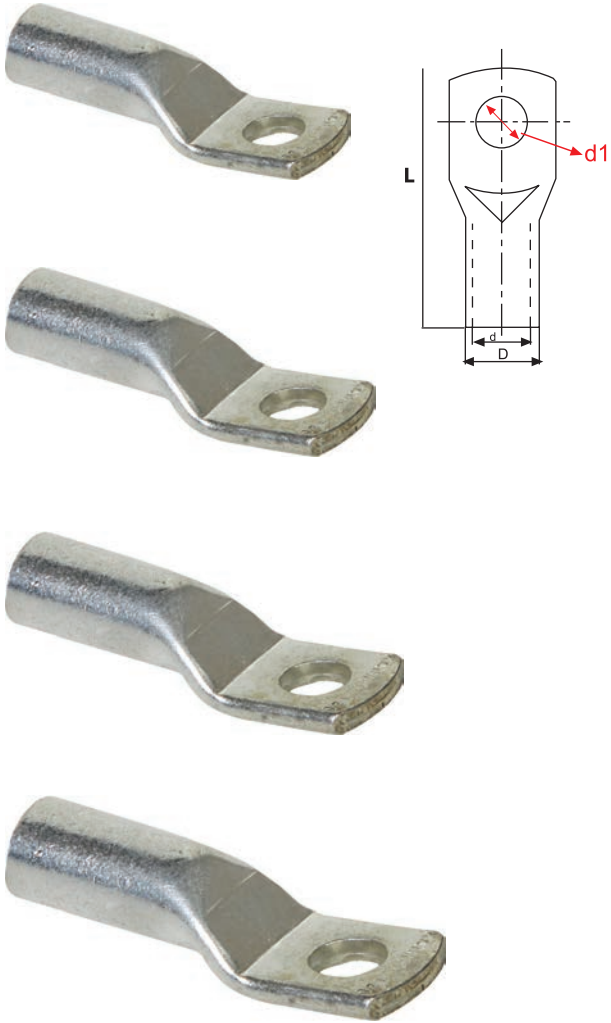

KOD	CİNSİ	ÇİVATA d1	D	d	b	L	a	KUTU ADET	ADET TL
C00071F	6'lık	M6	5.5	3.8	8.5	30.5	10	700	
C00371F	6'lık	M5	5.5	3.8	8.5	30.5	10	700	
C00072F	10'luk	M6	6	4.5	9	36	10	500	
C00372F	10'luk	M8	6	4.5	9	36	10	500	
C00073F	16'lık	M6	8.5	5.7	13	49	20	300	
C00373F	16'lık	M8	8.5	5.7	13	49	20	300	
C00074F	25'lik	M8	10	7	16	51	20	200	
C00374F	25'lik	M10	10	7	16	51	20	200	
C00075F	35'lik	M8	12.5	8.2	19	57	20	120	
C00375F	35'lik	M10	12.5	8.2	19	57	20	120	
C00076F	50'lik	M10	14.5	10	22	67	28	80	
C00376F	50'lik	M12	14.5	10	22	67	28	80	
C00077F	70'lik	M10	16.5	11.5	24	70	28	60	
C00377F	70'lik	M12	16.5	11.5	24	70	28	60	
C00078F	95'lik	M12	19	13.5	28	81	35	50	
C00378F	95'lik	M10	19	13.5	28	81	35	50	
C00079F	120'lik	M12	21	15.5	32	86	35	30	
C00379F	120'lik	M10	21	15.5	32	86	35	30	
C00080F	150'lik	M12	23.5	17	34	95	35	20	
C00380F	150'lik	M14	23.5	17	34	95	35	20	
C00081F	185'lik	M16	25.5	19	37	99	40	15	
C00381F	185'lik	M14	25.5	19	37	99	40	15	
C00082F	240'lik	M16	29	21.5	42	110	40	10	
C00382F	240'lik	M14	29	21.5	42	110	40	10	
C00083F	300'lük	M16	32	24.5	46	119	50	10	
C00383F	300'lük	M14	32	24.5	46	119	50	10	
C00084F	400'lük	M20	38.5	27.5	54	140	70	8	
C00384F	400'lük	M16	38.5	27.5	54	140	70	8	
C00085F	500'lük	M20	42	31	60	150	70	8	
C00385F	500'lük	M16	42	31	60	150	70	8	
C00086F	625'lik	M20	44	34.5	64	160	80	6	
C00386F	625'lik	M16	44	34.5	64	160	80	6	

F
İ
Y
A
T
V
E
S
T
O
K
S
O
R
U
N
U
Z

DIN 46235 Isıyla Daralan SKP Kılıfları



KOD	CİNSİ	KUTU AD.	ADET TL
C00121X	6'lık Kılıf	1000	
C00122X	10'luk Kılıf	800	
C00123X	16'lık Kılıf	400	
C00124X	25'lik Kılıf	200	
C00125X	35'lik Kılıf	200	
C00126X	50'lik Kılıf	200	
C00127X	70'lik Kılıf	100	
C00128X	95'lik Kılıf	40	
C00129X	120'lik Kılıf	40	
C00130X	150'lik Kılıf	40	
C00131X	185'lik Kılıf	40	
C00132X	240'lik Kılıf	40	
C00133X	300'lük Kılıf	20	
C00134X	400'lük Kılıf	20	
C00135X	500'lük Kılıf	20	
C00136X	625'lik Kılıf	20	

Alüminyum Baralar

KOD	CİNSİ	YAKLAŞIK KG.
R00007F	40x10 mm 1 Boy =6 mt. \leq 6,480 kg	
R00008F	50x10 mm 1 Boy =6 mt. \leq 8,100 kg	
R00009F	60x10 mm 1 Boy =6 mt. \leq 9,720 kg	
R00010F	80x10 mm 1 Boy =6 mt. \leq 12,960 kg	
R00011F	100x10 mm 1 Boy =6 mt. \leq 16,200 kg	
R00013F	120x10 mm 1 Boy =6 mt. \leq 19,440 kg	

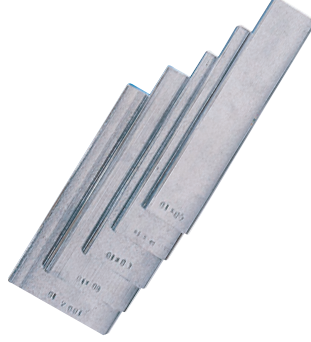

KOD	CİNSİ	YAKLAŞIK KG.
R00003F	30x5 mm 1 Boy =6 mt. \leq 2,430 kg	
R00004F	40x5 mm 1 Boy =6 mt. \leq 3,240 kg	
R00005F	50x5 mm 1 Boy =6 mt. \leq 4,050 kg	
R00006F	60x5 mm 1 Boy =6 mt. \leq 4,860 kg	
R00014F	80x5 mm 1 Boy =6 mt. \leq 6,480 kg	
R00015F	90x5 mm 1 Boy =6 mt. \leq 7,290 kg	
R00016F	100x5 mm 1 Boy =6 mt. \leq 8,100 kg	

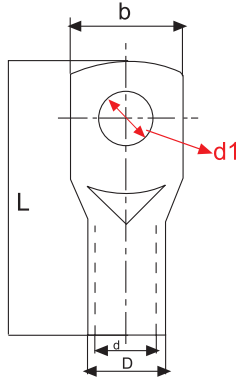
Alüminyum Bara Boyutları 6 mt. dir
Alüminyum Baralar İçin Fiyat Alınız.
Bakır Alüminyum Bimetalik SKP

KOD	CİNSİ	DELİK ÇAPİ d1	İÇ ÇAP d	DIŞ ÇAP D	UZUNLUK L	KUTU ADET	ADET \$
C00161X	16'lik	10,5	6,5	12	84	80	3,92 \$
C00162X	25'lik	10,6	6,5	16	84	80	3,92 \$
C00163X	35'lik	10,6	8	16	84	80	3,92 \$
C00164X	50'lik	13	9	20	84	60	5,16 \$
C00165X	70'lik	13	11	20	84	60	5,16 \$
C00166X	95'lik	13	12,5	20	84	60	5,16 \$
C00167X	120'lik	13	13,7	25	107	30	8,00 \$
C00168X	150'lik	13	15,5	25	107	30	8,00 \$
C00169X	185'lik	14,5	17	32	117	15	13,20 \$
C00170X	240'lik	14,5	19,5	32	117	15	13,20 \$
C00171X	300'lük	16	23,3	34	157		21,60 \$
C00172X	400'lük	16	26	37	157		21,60 \$

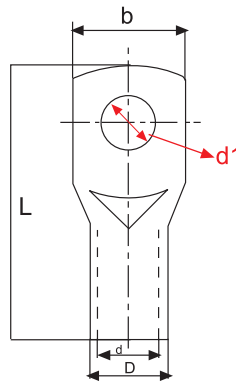
Al - Cu SKP DIN 48201

KOD	CİNSİ	DELİK ÇAPİ d1	İÇ ÇAP d	DIŞ ÇAP D	UZUNLUK L	KUTU ADET	ADET TL
C00050F	16'lik	6	5,6	10	56	400	53,80
C00051F	25'lik	8	7	12	64	300	68,50
C00052F	35'lik	8	8,2	14	73	200	91,00
C00053F	50'lik	10	10	16	81	120	115,50
C00054F	70'lik	12	11,4	18	94	100	142,80
C00055F	95'lik	12	13,4	22	102	60	172,00
C00056F	120'lik	12	15	24	112	60	203,00
C00057F	150'lik	12	16,5	26	114	45	218,50
C00058F	185'lik	12	18,5	28	125	40	258,50
C00059F	240'lik	12	21,2	32	141,5	25	292,50
C00060F	300'lük	16	24,5	34	143	20	371,50
C00061F	400'lük	22	27,5	37,5	160	10	499,50
C00062F	500'lük	22	30	42	170	10	646,00
C00063F	625'lik	22	35	50	210	10	999,00

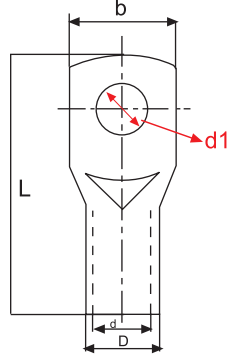

Özel Üretim Yapılır.

Alüminyum SKP DIN 46329

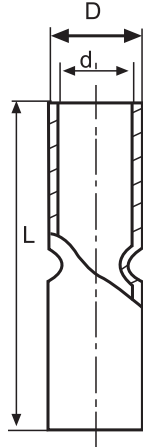

KOD	cinsi	DELİK ÇAPİ d1	İÇ ÇAP d	DIŞ ÇAP D	UZUNLUK L	KUTU ADET	ADET TL
C00030F	16'lik	6	5.6	10	56	450	21,20
C00031F	25'lik	8	7	12	64	300	28,40
C00032F	35'lik	8	8.2	14	73	200	36,20
C00033F	50'lik	10	10	16	81	150	46,95
C00034F	70'lik	12	11.4	18	94	100	59,75
C00035F	95'lik	12	13.4	22	102	75	87,80
C00036F	120'lik	12	15	24	112	60	112,90
C00037F	150'lik	12	16.5	26	114	45	118,20
C00038F	185'lik	12	18.5	28	125	40	155,60
C00039F	240'lik	12	21.2	32	141.5	30	183,50
C00040F	300'lük	16	24.5	34	143	25	210,90
C00041F	400'lük	22	27.5	37.5	160	10	302,90
C00042F	500'lük	22	30	42	170	10	470,90
C00043F	625'lik	22	35	50	210	10	675,80

Alüminyum Ek Boru Muf DIN 48201



KOD	cinsi	İÇ ÇAP d	DIŞ ÇAP D	UZUNLUK L	KUTU ADET	ADET TL
D00020F	16'lik	5.6	10	56	450	21,20
D00021F	25'lik	7	12	70	300	28,40
D00022F	35'lik	8.2	14	80	200	36,20
D00023F	50'lik	10	16	85	150	46,95
D00024F	70'lik	11.4	18	100	100	59,75
D00025F	95'lik	13.4	22	105	75	87,80
D00026F	120'lik	15	24	105	75	112,90
D00027F	150'lik	16.5	26	110	50	118,20
D00028F	185'lik	18.5	28	110	40	155,60
D00029F	240'lik	21.2	32	125	30	183,50
D00030F	300'lük	24.5	34	143	18	210,90
D00031F	400'lük	27.5	37.5	160	10	302,90
D00032F	500'lük	30	42	170	10	470,90
D00033F	625'lik	35	50	210	10	675,80

Isıyla Daralan Alüminyum ve AL-CU SKP Kılıfları

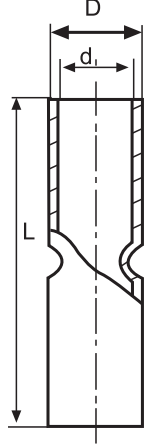

KOD	cinsi	KUTU AD.	ADET TL
C00141X	16'lik Kılıf	400	
C00142X	25'lik Kılıf	300	
C00143X	35'lik Kılıf	200	
C00144X	50'lik Kılıf	100	
C00145X	70'lik Kılıf	100	
C00146X	95'lik Kılıf	100	
C00147X	120'lik Kılıf	50	
C00148X	150'lik Kılıf	20	
C00149X	185'lik Kılıf	20	
C00150X	240'lik Kılıf	20	
C00151X	300'lük Kılıf	10	
C00152X	400'lük Kılıf	10	
C00153X	500'lük Kılıf	10	
C00154X	625'lik Kılıf	10	

Bakır Sıkmalı Ek Muf [SEM]

KOD	cinsi	İÇ ÇAP d	DIŞ ÇAP D	UZUNLUK L	KUTU ADET	ADET TL
D00004F	6'lık	3.8	5.2	20	1000	17,65
D00005F	10'luk	4.5	5.7	25	800	18,45
D00006F	16'lık	5.5	7.8	35	400	27,45
D00007F	25'lik	7	9	40	300	39,80
D00008F	35'lik	8.2	10.8	45	200	58,65
D00009F	50'lik	10	12.5	50	150	86,20
D00010F	70'lik	11.5	14.5	55	100	114,00
D00011F	95'lik	13.5	16.5	60	60	142,60
D00012F	120'lik	15.5	18.5	70	50	199,70
D00013F	150'lik	17	20.5	75	40	313,40
D00014F	185'lik	19	22.5	80	30	388,50
D00015F	240'lik	21.5	25.5	90	24	515,00
D00016F	300'lük	24.5	28.5	100	15	599,50
D00017F	400'lük	27.5	33		10	757,00
D00018F	500'lük	31	37		10	1.496,00
D00019F	625'lik	34.5	41		10	2.476,00

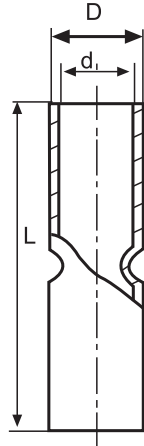
DIN 46267 Bakır Sıkmalı Ek Muf [SEM]

KOD	cinsi	İÇ ÇAP d	DIŞ ÇAP D	UZUNLUK L	KUTU ADET	ADET TL
D00301F	6'lık	3.8	5.5	30	1000	
D00302F	10'luk	4.5	6	35	800	
D00303F	16'lık	5.5	8.5	50	400	
D00304F	25'lik	7	10	50	300	
D00305F	35'lik	8.2	12.5	50	200	
D00306F	50'lik	10	14.5	56	150	
D00307F	70'lik	11.5	16.5	56	100	
D00308F	95'lik	13.5	19	70	60	
D00309F	120'lik	15.5	21	75	50	
D00310F	150'lik	17	23.5	85	40	
D00311F	185'lik	19	25.5	90	30	
D00312F	240'lik	21.5	29	95	24	
D00313F	300'lük	24.5	32	110	15	
D00314F	400'lük	27.5	38.5	150	10	
D00315F	500'lük	31	42	160	10	
D00316F	625'lik	34.5	44	160	10	

F
İ
Y
A
T

S
O
R
U
N
U
Z

Protolinler

KOD	cinsi	AMBALAJ AD.	ADET TL
D00041X	Protolin 500 gr.	6	350,00
D00040X	Protolin 1 kg.	6	599,00
D00042X	Protolin 5 kg.	1	2.790,00

Bakır İletkenler İçin Isı Büzüşmeli Kablo Ek Mufları (0.6-1kV)



KOD	cinsi	ADET TL
D00051X	4x1,5	238,20
D00052X	4x2,5	238,20
D00053X	4x4	238,20
D00054X	4x6	238,20
D00055X	4x10	287,60
D00056X	4x16	372,00
D00057X	4x25	457,75
D00058X	4x35	521,00
D00059X	4x50	555,80
D00060X	4x70	840,00
D00061X	4x95	980,00
D00062X	4x120	1.355,00
D00063X	4x150	1.450,00
D00064X	4x185	1.630,00
D00065X	4x240	2.225,00
D00066X	4x300	2.590,00
D00067X	4x400	2.970,00
D00068X	3x16+10	369,95
D00069X	3x25+16	445,00
D00070X	3x35+16	499,00
D00071X	3x50+25	544,50
D00072X	3x70+35	786,80
D00073X	3x95+50	988,00
D00074X	3x120+70	1.340,00
D00075X	3x150+70	1.442,00
D00076X	3x185+95	1.617,00
D00077X	3x240+120	2.228,00
D00078X	3x300+150	2.588,00
D00079X	3x400+185	2.955,00



KOD	cinsi	ADET TL
D00081X	3x1,5	217,80
D00082X	3x4	217,80
D00083X	3x6	217,80
D00084X	3x10	268,20
D00085X	3x16	358,90
D00086X	3x25	442,60
D00087X	3x35	497,00
D00088X	3x50	534,40
D00089X	3x70	799,55
D00090X	3x95	931,60
D00091X	3x120	1.169,50
D00092X	3x150	1.299,60
D00093X	3x185	1.577,00
D00094X	3x240	2057,00
D00095X	3x300	2.420,00
D00096X	3x400	2.790,00



KOD	cinsi	ADET TL
D00101X	2x1,5 - 2x4	198,00
D00102X	2x6 - 2x10	198,00
D00103X	2x16 - 2x25	272,50
D00104X	2x35 - 2x50	436,50
D00105X	2x70 - 2x95	746,00
D00106X	2x120 - 2x150	850,00
D00107X	2x185	1.055,60
D00108X	2x240	1.250,00
D00109X	2x300	1.496,00
D00110X	2x400	1.673,00



KOD	cinsi	ADET TL
D00115X	1x1,5 - 1x4	165,40
D00116X	1x6 - 1x10	165,40
D00117X	1x16 - 1x25	228,90
D00118X	1x35 - 1x50	358,90
D00119X	1x70 - 1x95	599,90
D00120X	1x120 - 1x150	702,80
D00121X	1x185 - 1x240	936,00
D00122X	1x300 - 1x400	1.115,00

Alüminyum İletkenler İçin Isı Büzüşmeli Kablo Ek Mufları (0.6-1kV)

KOD	cinsi	ADET TL
D00130X	4x16	362,90
D00131X	4x25	444,80
D00132X	4x35	512,00
D00133X	4x50	548,50
D00134X	4x70	840,80
D00135X	4x95	988,00
D00136X	4x120	1.349,00
D00137X	4x150	1.460,00
D00138X	4x185	1.620,00
D00139X	4x240	2.219,00
D00140X	4x300	2.585,00
D00141X	4x400	2.955,00
D00142X	3x25+16	435,50
D00143X	3x35+16	499,00
D00144X	3x50+25	529,00
D00145X	3x70+35	818,00
D00146X	3x95+50	971,00
D00147X	3x120+70	1.319,00
D00148X	3x150+70	1.450,00
D00149X	3x185+95	1.585,00
D00150X	3x240+120	2.180,00
D00151X	3x300+150	2.579,00
D00152X	3x400+185	2.947,00



KOD	cinsi	ADET TL
D00161X	3x25	429,50
D00162X	3x35	486,90
D00163X	3x50	522,00
D00164X	3x70	784,00
D00165X	3x95	909,00
D00166X	3x120	1.142,00
D00167X	3x150	1.299,00
D00168X	3x185	1.551,00
D00169X	3x240	1.999,00
D00170X	3x300	2.399,00
D00171X	3x400	2.770,00



KOD	cinsi	ADET TL
D00181X	2x25	263,90
D00182X	2x35 - 2x50	425,50
D00183X	2x70 - 2x95	725,00
D00184X	2x120 - 2x150	829,00
D00185X	2x185	1.035,40
D00186X	2x240	1.217,90
D00187X	2x300	1.468,00
D00188X	2x400	1.670,00

KOD	cinsi	ADET TL
D00191X	1x25	218,80
D00192X	1x35 - 1x50	343,80
D00193X	1x70 - 1x95	584,00
D00194X	1x120 - 1x150	678,00
D00195X	1x185 - 1x240	915,00
D00196X	1x300 - 1x400	1.095,00



Şeffaf Yeraltı Buatları

KOD	KABLO KESİDİ	KULLANILACAK REÇİNE MİKTARI	KUTU ADET	ADET €
D00451F	AGR 01 [4x1.5 - 4x25 mm ²]	500 gr.	1	7,70 €
D00452F	AGR 02 [4x35 - 4x50 mm ²]	750 gr.	1	11,55 €
D00453F	AGR 03 [4x70 - 4x95 mm ²]	1250 gr.	1	15,40 €
D00454F	AGR 04 [4x125 - 4x150 mm ²]	4000 gr.	1	26,95 €
D00455F	AGR 05 [4x185 - 4x240 mm ²]	8000 gr.	1	32,75 €

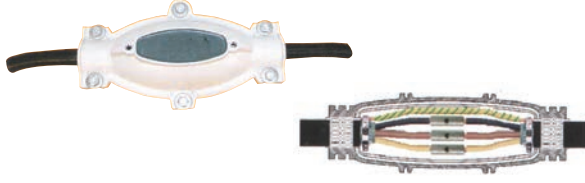
Düz Tip Yeraltı Buatları

KOD	KABLO KESİDİ	KULLANILACAK REÇİNE MİKTARI	KUTU ADET	ADET €
D00461F	YGR 01 [4x10 - 4x25 mm ²]	1200 gr.	1	13,50 €
D00462F	YGR 02 [4x35 - 4x120 mm ²]	3750 gr.	1	25,00 €
D00463F	YGR 03 [4x150 - 4x300 mm ²]	10000 gr.	1	35,65 €

Yeniden kullanılabilir.Reçine fiyata dahil değildir.

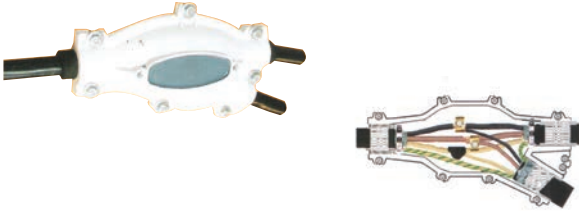
Y Tipi Yeraltı Buatları

KOD	KABLO KESİDİ	KULLANILACAK REÇİNE MİKTARI	KUTU ADET	ADET €
D00471F	Y YGR 01 [4x10 - 4x25 mm ²]	1200 gr.	1	15,40 €
D00472F	Y YGR 01-A [4x35 - 4x70 mm ²]	3750 gr.	1	27,95 €
D00473F	Y YGR 02 [4x50 - 4x120 mm ²]	4000 gr.	1	36,60 €
D00474F	Y YGR 03 [4x150 - 4x300 mm ²]	7500 gr.	1	71,25 €

Yeniden kullanılabilir.Reçine fiyata dahil değildir.

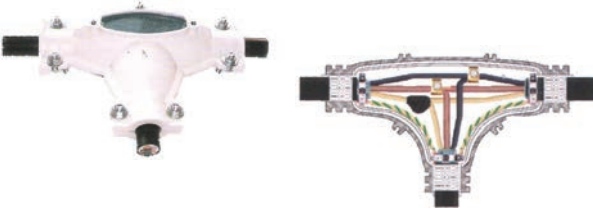
T Tipi Yeraltı Buatları

KOD	KABLO KESİDİ	KULLANILACAK REÇİNE MİKTARI	KUTU ADET	ADET €
D00481F	T YGR 01 [4x10 - 4x25 mm ²]	1200 gr.	1	23,20 €
D00482F	T YGR 02 [4x35 - 4x120 mm ²]	3750 gr.	1	50,10 €
D00483F	T YGR 03 [4x150 - 4x300 mm ²]	10000 gr.	1	73,20 €

Yeniden kullanılabilir.Reçine fiyata dahil değildir.

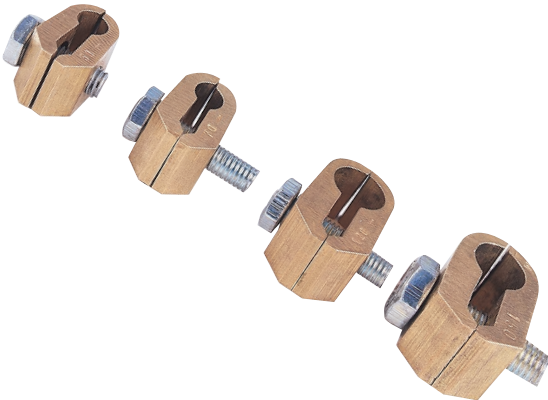
Kanca Serfİller [MS-58 Pirinç]

KOD	CİNSİ	KABLO ÇAPİ Ø mm ²	KUTU ADET	ADET TL
B00056F	16'lık	5	350	107,50
B00057F	25'lik	6	300	121,40
B00058F	35'lik	8	300	127,00
B00059F	50'lik	9	250	138,00
B00060F	70'lik	11	200	198,00
B00061F	95'lik	13	175	228,00
B00062F	120'lik	14	150	260,00
B00063F	150'lik	16	100	285,00
B00064F	185'lik	18	75	372,00
B00065F	240'lik	21	60	490,00

Standart U Klemensler

KOD	CİNSİ	KUTU ADET	ADET TL
E00001F	6'lık	400	35,20
E00002F	10'luk	250	48,50
E00003F	16'lık	150	71,70
E00004F	25'lik	100	87,80
E00005F	35'lik	75	99,40
E00006F	50'lik	50	156,60
E00007F	70'lik	40	199,50
E00008F	95'lik	30	295,90
E00009F	120'lik	20	389,90
E00010F	150'lik	15	524,50

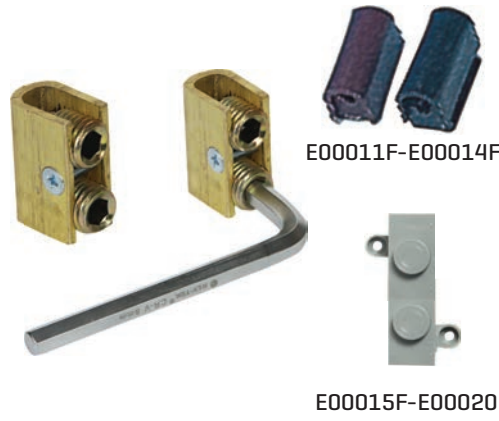

U Klemens Kaynakları

KOD	CİNSİ	ADET TL
E00011F	6'lık	14,90
E00012F	10'luk	14,90
E00013F	16'lık	14,90
E00014F	25'lik	16,60
E00015F	35'lik	21,50
E00016F	50'lik	23,20
E00017F	70'lik	27,40
E00018F	95'lik	27,90
E00019F	120'lik	30,70
E00020F	150'lik	32,10

Vidalar Alyan Başlıdır. - MS-58 Pirinç Malzemeden Üretilmiştir.

Sabitlenebilir İzoleli U Klemensler



KOD	CİNSİ	KUTU ADET	ADET TL
E00023F	16'lık	100	92,60
E00024F	25'lik	100	110,70
E00025F	35'lik	75	130,90
E00026F	50'lik	55	190,80
E00027F	70'lik	45	237,90
E00028F	95'lik	36	334,00
E00029F	120'lik	26	432,60
E00030F	150'lik	23	570,60

Vidalar Alyan Başlıdır
MS-58 Pirinç Malzemeden Üretilmiştir.

Sabitlenebilir Kolon Klemensleri 200 °C [Gri]

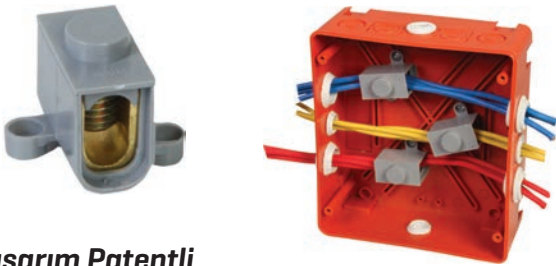

KOD	CİNSİ	KUTU ADET	ADET TL
G00083F	No: 3 Sabitlenebilir Kolon Klemensi 10-16 mm ²	150	44,20
G00084F	No: 4 Sabitlenebilir Kolon Klemensi 16-25 mm ²	140	51,50
G00085F	No: 5 Sabitlenebilir Kolon Klemensi 25-35 mm ²	130	64,30
G00086F	No: 6 Sabitlenebilir Kolon Klemensi 35-50 mm ²	110	72,30
G00087F	No: 7 Sabitlenebilir Kolon Klemensi 50-70 mm ²	90	90,60
G00088F	No: 8 Sabitlenebilir Kolon Klemensi 70-95 mm ²	50	147,60

Tasarım Patentli
Halogen Free Alev Yayımaz

Vidalı Klemens İçleri



KOD	CİNSİ	AKIM [A]	KUTU ADET	ADET TL
G00061F	No: 1 2.5 - 4 mm ²	32	100	7,90
G00062F	No: 2 4 - 6 mm ²	41	100	9,20
G00063F	No: 3 6 - 10 mm ²	57	100	11,80
G00064F	No: 4 10 - 16 mm ²	76	100	13,50
G00065F	No: 5 16 - 25 mm ²	101	100	17,00

MS-58 Pirinç Malzemeden Üretilmiştir.

Tırnaklı Klemensler

KOD	CİNSİ		KUTU ADET	ADET TL
F00001F	No: 1	10 mm	600	63,95
F00002F	No: 2	16 mm	350	95,00
F00003F	No: 3	25 mm	200	142,40
F00004F	No: 4	35 mm	175	179,30
F00005F	No: 5	50 mm	90	305,50
F00006F	No: 6	70 mm	50	485,60
F00007F	No: 7	95 mm	50	495,60
F00008F	No: 8	120 mm	40	572,60

MS-58 Pirinç Malzemedan Üretilmişir.

Pirinç İletken Klemensler

KOD	CİNSİ	SIKMA SAHASI		KUTU ADET	ADET TL
B00105F	Pirinç 16-16	1 Vidalı	4-16 mm ²	350	137,20
B00099F	Pirinç 25-25	1 Vidalı	4-25 mm ²	300	212,50
B00113F	Pirinç 35-35	1 Vidalı	6-35 mm ²	250	234,00
B00100F	Pirinç 50-50	1 Vidalı	6-50 mm ²	200	312,60
B00101F	Pirinç 70-70	1 Vidalı	10-70 mm ²	150	391,40
B00102F	Pirinç 95-95	2 Vidalı	10-95 mm ²	100	679,70
B00103F	Pirinç 120-120	2 Vidalı	16-120 mm ²	100	824,70
B00104F	Pirinç 150-150	3 Vidalı	25-150 mm ²	75	1.263,00

MS-58 Pirinç Malzemedan Üretilmişir.

Bakır İletken Klemensler

KOD	CİNSİ	SIKMA SAHASI		KUTU ADET	ADET TL
B00108F	Cu 16-16	1 Vidalı	4-16 mm ²	350	157,70
B00093F	Cu 25-25	1 Vidalı	4-25 mm ²	300	253,90
B00109F	Cu 35-35	1 Vidalı	6-35 mm ²	200	280,00
B00094F	Cu 50-50	1 Vidalı	6-50 mm ²	175	379,80
B00095F	Cu 70-70	1 Vidalı	10-70 mm ²	150	479,00
B00096F	Cu 95-95	2 Vidalı	10-95 mm ²	100	822,00
B00097F	Cu 120-120	2 Vidalı	16-120 mm ²	100	1.046,00
B00098F	Cu 150-150	3 Vidalı	25-150 mm ²	75	1.567,00
B00106F	Cu 185-185	3 Vidalı	25-185 mm ²	50	2.207,00
B00107F	Cu 240-240	3 Vidalı	35-240 mm ²	40	2.783,00

C Bakır Klemensler

KOD	K1 K2	KUTU AD.	ADET TL
B00216F	C 16 - 16	750	44,60
B00217F	C 25 - 25	350	66,30
B00218F	C 35 - 35	250	101,00
B00219F	C 50 - 50	250	150,50
B00220F	C 70 - 70	150	210,40
B00221F	C 95 - 95	120	341,40
B00222F	C 120 - 120	100	411,80
B00223F	C 150 - 150	100	497,50
B00224F	C 185 - 185	50	636,50
B00225F	C 240 - 240	50	699,50
B00459F	C 300 - 300	50	1.333,00



KOD	K1 K2	KUTU AD.	ADET TL
B00116F	C 16 - 25	750	64,00
B00264F	C 16 - 35	400	70,00
B00117F	C 25 - 35	350	87,50
B00123F	C 25 - 70	200	148,50
B00118F	C 35 - 50	250	162,80
B00266F	C 35 - 70	250	201,00
B00451F	C 35 - 300	50	578,00
B00119F	C 50 - 70	250	206,70
B00120F	C 70 - 95	150	292,50
B00269F	C 95 - 25	100	169,50
B00270F	C 95 - 35	100	189,00
B00421F	C 120 - 10	100	244,90
B00121F	C 120 - 95	120	385,80
B00122F	C 120 - 150	100	420,00
B00273F	C 150 - 35	100	279,50
B00456F	C 150 - 300	50	841,80
B00444F	C 240 - 10	50	403,00
B00124F	C 240 - 35	50	437,40
B00255F	C 240 - 50	50	463,50
B00256F	C 240 - 70	50	482,00
B00257F	C 240 - 95	50	507,90
B00258F	C 240 - 120	50	555,60
B00259F	C 240 - 150	50	630,90
B00260F	C 240 - 185	50	688,95



İstek Üzerine, net fiyat üzerinden %10 Fiyat Farkı uygulanarak Kalay Kaplama Yapılır.

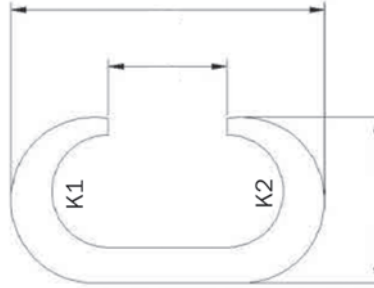

H Bakır Klemensler

KOD	K1 K2	KUTU AD.	ADET TL
B00126F	H 16 - 16	600	46,30
B00127F	H 25 - 25	500	75,95
B00128F	H 35 - 35	400	122,65
B00129F	H 50 - 50	350	171,20
B00130F	H 70 - 70	200	210,00
B00131F	H 95 - 95	160	248,40
B00132F	H 120 - 120	140	294,40
B00133F	H 150 - 150	100	455,80
B00134F	H 185 - 185	50	525,80
B00135F	H 240 - 240	50	587,00

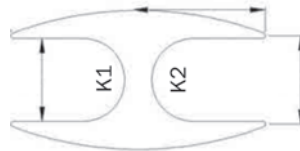

İstek Üzerine net fiyat üzerinden %10 Fiyat Farkı ile Kalay Kaplama Yapılır.

KOD	K1 K2	KUTU AD.	ADET TL
B00226F	H 16 - 25	400	59,00
B00227F	H 25 - 35	400	103,00
B00234F	H 35 - 50	400	122,50
B00228F	H 35 - 70	400	164,20
B00229F	H 35 - 95	350	183,00
B00236F	H 35 - 120	200	201,60
B00235F	H 50 - 70	200	192,60
B00230F	H 50 - 95	200	199,70
B00231F	H 50 - 120	160	221,80
B00237F	H 70 - 95	140	225,50
B00233F	H 70 - 120	140	234,50
B00232F	H 95 - 120	140	268,00
B00238F	H 95 - 185	140	455,60



KOD	çinsi	KUTU AD.	ADET \$
502255	H - C Klemens Sıkma Pensesi [CYO-400 16-400]	1	1.600,00 \$
502261	H - C Klemens Sıkma Çenesi Takım	1 Tk.	235,00 \$

Her Klemens Ölçüsü İçin Ayrı Çene Takımı Kullanılır

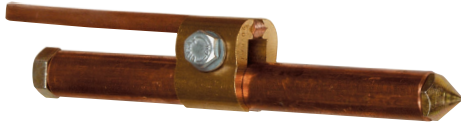
Som Bakır Topraklama Çubukları

KOD	cinsi	KUTU ADET	ADET TL
M00000X	Ø 12 Komple Top. Çubuğu 85 cm	20	Sorunuz
M00011X	Ø 13 Komple Top. Çubuğu 90 cm	20	Sorunuz
M00012X	Ø 14 Komple Top. Çubuğu 1 mt	10	Sorunuz
M00005X	Ø 16 Komple Top. Çubuğu 1 mt	10	Sorunuz
M00006X	Ø 16 Komple Top. Çubuğu 1.5 mt	15	Sorunuz
M00004X	Ø 18 Komple Top. Çubuğu 1 mt	10	Sorunuz
M00003X	Ø 18 Komple Top. Çubuğu 1.5 mt	15	Sorunuz
M00002X	Ø 20 Komple Top. Çubuğu 1 mt	15	Sorunuz
M00001X	Ø 20 Komple Top. Çubuğu 1.5 mt	25	Sorunuz



KOD	cinsi	KUTU ADET	ADET TL
M00051F	Ø 13 Kelepçe	250	101,00
M00052F	Ø 14 Kelepçe	250	110,00
M00053F	Ø 16 Kelepçe	150	192,50
M00054F	Ø 18 Kelepçe	125	250,50
M00055F	Ø 20 Kelepçe	100	280,40
M00056F	Ø18-Ø20-Ø22'lik Çift Yollu Kelepçe	50	Sorunuz
M00007X	Çakma Ucu	100	Sorunuz
M00008X	Çakma Tamponu	100	Sorunuz
M00009X	Redüktör [Ek Elemanı]	100	Sorunuz

KOD	cinsi	KUTU ADET	ADET TL
M00010X	Demir Topraklama Çubuğu 1 mt (Piyasa)	25	Sorunuz

Bakır Kaplama Çelik Topraklama Çubukları

KOD	cinsi	KUTU ADET	ADET TL
M00103X	Ø 16 - 1 mt Bakır Kaplı Topraklama Çubuğu	20	Sorunuz
M00105X	Ø 20 - 1 mt Bakır Kaplı Topraklama Çubuğu	20	Sorunuz
M00106X	Ø 16 - 1.5 mt Bakır Kaplı Topraklama Çubuğu	20	Sorunuz
M00108X	Ø 20 - 1,5 mt Bakır Kaplı Topraklama Çubuğu	20	Sorunuz

250 ve 50 Micron Bakır Kaplama Mevcuttur.

Topraklama Aksesuarları

KOD	cinsi	KUTU ADET	ADET TL
M00036F	Bakır Bara Tutucu 25x3	50	Sorunuz
M00037F	Bakır Bara Tutucu 30x3	50	Sorunuz

M00016X	Gem Tozu [11 kg] İthal	1	Sorunuz
M00015X	Gem Tozu [10 kg] Yerli	1	Sorunuz

KOD	cinsi	KUTU ADET	ADET TL
M00121X	H Tipi Çubuk Başlığı Ø 20 İletken 50'lik	50	Sorunuz
M00122X	H Tipi Çubuk Başlığı Ø 18 İletken 50'lik	50	Sorunuz
M00123X	M Tipi Çubuk Başlığı Ø20 1x50	50	Sorunuz
M00124X	M Tipi Çubuk Başlığı Ø20 2x50	50	Sorunuz
M00125X	Kare Klemens 50-50	50	Sorunuz
M00126X	Paralel Ek Klemens 2x95	50	Sorunuz
M00127X	Paralel Ek Klemens 2x50	50	Sorunuz
M00128X	Kare Klemens 4'lü Tip 50'lik	50	Sorunuz
M00129X	Tekli Plon Kroşe Plastik Tutuculu	50	Sorunuz
M00130X	İkili Plon Kroşe Galvaniz Tutuculu	50	Sorunuz
M00131X	Tekli Plon Kroşe Bakır Tutuculu	50	Sorunuz
M00132X	İkili Plon Kroşe Bakır Tutuculu	50	Sorunuz
M00135X	Test Klemensi 2x50	50	Sorunuz
M00136X	Tirfonlu İniş Klemensi 2x50	50	Sorunuz

KOD	cinsi	KUTU ADET	ADET TL
M00171X	PARATONER [Koruma Alanı 200 mt]	1	Sorunuz

Örgülü Bakırlar



KOD	CİNSİ		AMB. METRE	METRE TL
M00091X	10'luk	Örgülü Bakır	300	Sorunuz
M00092X	16'lik	Örgülü Bakır	150	Sorunuz
M00093X	25'lik	Örgülü Bakır	100	Sorunuz
M00094X	35'lik	Örgülü Bakır	100	Sorunuz
M00095X	50'lik	Örgülü Bakır	100	Sorunuz
M00096X	70'lik	Örgülü Bakır	100	Sorunuz
M00097X	95'lik	Örgülü Bakır	100	Sorunuz
M00098X	120'lik	Örgülü Bakır	100	Sorunuz
M00161X	Q8 Bakır Tel		100	Sorunuz
M00163X	Q8 Bakır Kaplamalı Alüminyum Tel		100	Sorunuz

Bakır Topraklama Levhası



KOD	CİNSİ	KUTU ADET	ADET TL
M00017X	70x70 1 mm Topraklama Levhası	5	Sorunuz
M00013X	70x70 1.5 mm Topraklama Levhası	5	Sorunuz
M00014X	70x70 2 mm Topraklama Levhası	5	Sorunuz

Bakır Topraklama Baraları



KOD	CİNSİ	ADET TL
M00030X	25x3 Bakır Bara 1mt \pm 0,70 kg	Sorunuz
M00031X	30x3 Bakır Bara 1mt \pm 0,80 kg	Sorunuz
M00032X	30x5 Bakır Bara 1mt \pm 1,40 kg	Sorunuz
M00033X	40x5 Bakır Bara 1mt \pm 1,80 kg	Sorunuz
M00029X	40x10 Bakır Bara 1mt \pm 3,60 kg	Sorunuz
M00034X	50x10 Bakır Bara 1mt \pm 4,50 kg	Sorunuz

Galvaniz Topraklama Elemanları



KOD	CİNSİ	KUTU mt.	ADET TL
M00060X	30x2 Kalaylı Topraklama Şeridi	50 mt	Sorunuz
M00061X	30x3 Galvaniz Daldırma Topraklama Şeridi	50 mt	Sorunuz
M00062X	30x3 Alüminyum Topraklama Şeridi	50 mt	Sorunuz
M00063X	30x3,5 Galvaniz Topraklama Şeridi	50 mt	Sorunuz
M00064X	40x4 Galvaniz Topraklama Şeridi	50 mt	Sorunuz
M00065X	Galvaniz Köşebent Kelepçesi		Sorunuz

M00081X	40x40 4 mm Topraklama Kazığı 1 mt	1	Sorunuz
M00082X	50x50 5 mm Topraklama Kazığı 1,5 mt	1	Sorunuz

M00075X	Ölüm Tehlikesi	200	Sorunuz
M00162X	Antistatik Topraklama Levhası Tek El	1	Sorunuz
M00164X	Antistatik Topraklama Levhası Çift El	1	Sorunuz

M00113F	Şeritten Demire ve Şeritten Şeride Kanca Bağlantı Klemensi [Galvaniz]	250	Sorunuz
---------	---	-----	---------

M00115X	Galvaniz Şeritten Şeride Bağ. Kl. 4 Köşe	20	Sorunuz
M00116X	Galvaniz Şeritten Demire Bağ. Kl. 4 Köşe	20	Sorunuz



[EURO] Açık Tip Büyük Boy Ray Klemensler

Gövde: N66. VO

İç: Nikel Kaplı MS 58

KOD	CİNSİ		AMPER	KUTU ADET	ADET TL
U**020F	2.5 mm ²	Euro Açık Tip Ray Klm.	24	100	32,90
U**021F	4 mm ²	Euro Açık Tip Ray Klm.	32	100	36,10
U**022F	6 mm ²	Euro Açık Tip Ray Klm.	41	100	58,10
U**023F	10 mm ²	Euro Açık Tip Ray Klm.	57	100	81,20
U**024F	16 mm ²	Euro Açık Tip Ray Klm.	76	60	117,80
U**025F	25 mm ²	Euro Açık Tip Ray Klm.	100	40	147,90
U**026F	35 mm ²	Euro Açık Tip Ray Klm.	125	36	201,50
U00014F	Durdurucu			80	44,85
U**030F	Nihayet Plakası [2.5-4-6-10]			100	8,90
U**031F	Nihayet Plakası 16 mm ²			100	11,60
U**032F	Nihayet Plakası 25 mm ² -35 mm ²			100	14,10

Bej	Gri	Kahve	Mavi	Sarı	Kırmızı	Yeşil	Siyah
** → BE	GR	KA	MA	SA	KI	YE	SI

Sipariş Anında Kod'un İçindeki (**) Yerine Renk Kodunu Yazınız

[EURO] Açık Tip Ray Klemens Köprüleri

KOD	CİNSİ		KUTU ADET	ADET TL
U00210F	2.5 mm ²	10'lu Ray Klemens Köprüsü	50	110,30
U00220F	4 mm ²	10'lu Ray Klemens Köprüsü	50	132,20
U00230F	6 mm ²	10'lu Ray Klemens Köprüsü	50	149,60
U00240F	10 mm ²	10'lu Ray Klemens Köprüsü	50	162,50
U00250F	16 mm ²	10'lu Ray Klemens Köprüsü	50	203,80
U00260F	25 mm ²	10'lu Ray Klemens Köprüsü	50	248,30
U00270F	35 mm ²	10'lu Ray Klemens Köprüsü	50	290,00

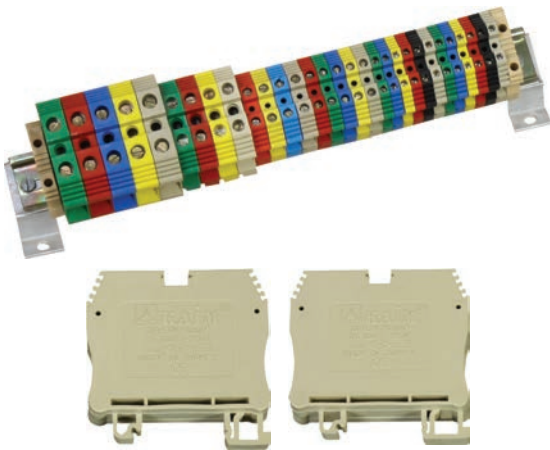
[EURO] Kapalı Tip Büyük Boy Ray Klemensler

KOD	CİNSİ		AMPER	KUTU ADET	ADET TL
U**001F	2.5 mm ²	Euro Kapalı Tip Ray Klm.	24	84	34,10
U**002F	4 mm ²	Euro Kapalı Tip Ray Klm.	32	84	37,40
U**003F	6 mm ²	Euro Kapalı Tip Ray Klm.	41	84	61,50
U**004F	10 mm ²	Euro Kapalı Tip Ray Klm.	57	88	84,20
U**005F	16 mm ²	Euro Kapalı Tip Ray Klm.	76	54	120,90
U**006F	25 mm ²	Euro Kapalı Tip Ray Klm.	100	38	152,80
U**007F	35 mm ²	Euro Kapalı Tip Ray Klm.	125	34	205,90
U**008F	50 mm ²	Euro Kapalı Tip Ray Klm.	150	24	521,35
U**009F	70 mm ²	Euro Kapalı Tip Ray Klm.	192	20	588,35
U00014F	Durdurucu			80	44,85

Bej	Gri	Kahve	Mavi	Sarı	Kırmızı	Yeşil	Siyah
** → BE	GR	KA	MA	SA	KI	YE	SI

Sipariş Anında Kod'un İçindeki (**) Yerine Renk Kodunu Yazınız

Gövde: N66. VO

İç: Nikel Kaplı MS58

[KORK] Kapalı Orta Boy Ray Klemensler



KOD	CİNSİ		AMPER	KUTU ADET	ADET TL
U**041F	2.5 mm ²	Kapalı Tip Ray Klemens	24	100	29,20
U**042F	4 mm ²	Kapalı Tip Ray Klemens	32	100	30,95
U**043F	6 mm ²	Kapalı Tip Ray Klemens	41	100	49,50
U**044F	10 mm ²	Kapalı Tip Ray Klemens	57	100	68,55
U**045F	16 mm ²	Kapalı Tip Ray Klemens	76	50	100,90
U**046F	25 mm ²	Kapalı Tip Ray Klemens	100	40	126,80
U**047F	35 mm ²	Kapalı Tip Ray Klemens	125	40	154,80
U00014F	Durdurucu			80	44,85

Bej	Gri	Kahve	Mavi	Sarı	Kırmızı	Yeşil	Siyah
** → BE	GR	KA	MA	SA	KI	YE	Si

Gövde: N66. V0

İç: Nikel Kaplı MS 58

Sipariş Anında Kod'un İçindeki () Yerine Renk Kodunu Yazınız**

[KORK] Ray Klemens Köprüleri



KOD	CİNSİ		KUTU ADET	ADET TL
U00610F	2.5 mm ²	10'lu Ray Klemens Köprüsü	50	101,50
U00620F	4 mm ²	10'lu Ray Klemens Köprüsü	50	121,00
U00630F	6 mm ²	10'lu Ray Klemens Köprüsü	50	139,80
U00640F	10 mm ²	10'lu Ray Klemens Köprüsü	50	152,20

Sigortalı Ray Klemens ve Sigortaları



KOD	CİNSİ	KUTU ADET	ADET TL
U00061F	2.5 - 6'lık Sigortalı Ray Klemens	60	166,60
U00071X	Cam Sigortalar 1A-2A-2,5A-3A-4A-5A 6A-10A	100	25,90

Topraklama Ray Klemensler

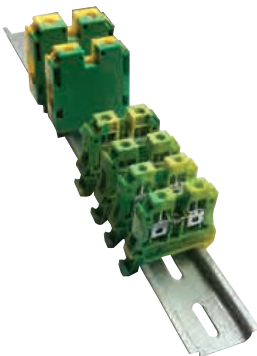

KOD	CİNSİ		KUTU ADET	ADET TL
U00051X	2.5 mm ²	Sarı-Yeşil Topraklama Klemensi	100	Sorunuz
U00052X	4 mm ²	Sarı-Yeşil Topraklama Klemensi	100	Sorunuz
U00053X	6 mm ²	Sarı-Yeşil Topraklama Klemensi	80	Sorunuz
U00054X	10 mm ²	Sarı-Yeşil Topraklama Klemensi	70	Sorunuz
U00055X	16 mm ²	Sarı-Yeşil Topraklama Klemensi	36	Sorunuz
U00056X	35 mm ²	Sarı-Yeşil Topraklama Klemensi	20	Sorunuz

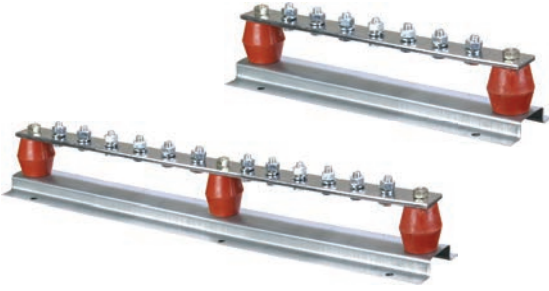
Eş Potansiyel Baralar

Civata Aralıkları Bara Montajına Uygundur

KOD	cinsi	AMPER	KUTU ADET	ADET TL
M00201F	30x3 21 cm [M8-5 Cıvatalı]	200	5	798,00
M00202F	30x3 30 cm [M8-7 Cıvatalı]	200	5	1.026,40
M00203F	30x3 40 cm [M8-9 Cıvatalı]	200	5	1.280,00
M00204F	30x3 50 cm [M8-12 Cıvatalı]	200	5	1.642,00

M00044F	30x5 21 cm [M8-5 Cıvatalı]	300	5	1.081,00
M00046F	30x5 30 cm [M8-7 Cıvatalı]	300	5	1.426,00
M00048F	30x5 40 cm [M8-9 Cıvatalı]	300	5	1.811,00
M00047F	30x5 50 cm [M8-12 Cıvatalı]	300	5	2.205,00

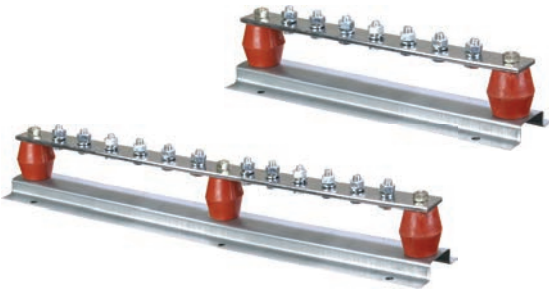
Eş Potansiyel Baralar

Civata Aralıkları SKP Montajına Uygundur

KOD	cinsi	AMPER	KUTU ADET	ADET TL
M00211F	30x5 17 cm [M8-5 Cıvatalı]	300	5	944,00
M00212F	30x5 22 cm [M8-7 Cıvatalı]	300	5	1.164,00
M00213F	30x5 27 cm [M8-9 Cıvatalı]	300	5	1.350,00
M00214F	30x5 35 cm [M8-12 Cıvatalı]	300	5	1.762,00

M00221F	30x3 17 cm [M8-5 Cıvatalı]	200	5	737,00
M00222F	30x3 22 cm [M8-7 Cıvatalı]	200	5	872,00
M00223F	30x3 27 cm [M8-9 Cıvatalı]	200	5	1.019,00
M00224F	30x3 35 cm [M8-12 Cıvatalı]	200	5	1.334,00

Eş Potansiyel Baralar



Civata Aralıkları Bara Montajına Uygundur

KOD	cinsi	AMPER	KUTU ADET	ADET TL
M00231F	40x5 21 cm [M8-5 Cıvatalı]	360	5	1.322,80
M00232F	40x5 30 cm [M8-7 Cıvatalı]	360	5	1.741,00
M00233F	40x5 40 cm [M8-9 Cıvatalı]	360	5	2.210,00
M00234F	40x5 50 cm [M8-12 Cıvatalı]	360	5	2.783,00

Eş Potansiyel Baralar

Civata Aralıkları SKP Montajına Uygundur

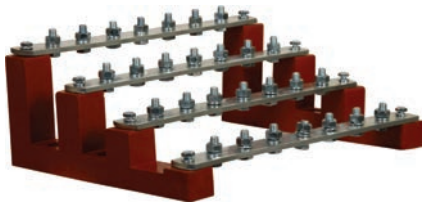
KOD	cinsi	AMPER	KUTU ADET	ADET TL
M00241F	40x5 17 cm [M8-5 Cıvatalı]	360	5	1.126,00
M00242F	40x5 22 cm [M8-7 Cıvatalı]	360	5	1.366,00
M00243F	40x5 27 cm [M8-9 Cıvatalı]	360	5	1.626,00
M00244F	40x5 35 cm [M8-12 Cıvatalı]	360	5	1.910,00

4 Kademeli Eş Potansiyel Baralar

Civata Aralıkları SKP Montajına Uygundur

KOD	cinsi	AMPER	KUTU ADET	ADET TL
M00151F	30/5 17 cm [M8-5 Cıvatalı]	300	6	3.333,00
M00152F	30/5 22 cm [M8-7 Cıvatalı]	300	5	4.130,00
M00153F	30/5 27 cm [M8-9 Cıvatalı]	300	4	4.926,00
M00154F	30/5 35 cm [M8-12 Cıvatalı]	300	3	6.190,00

Pano Topraklama Klemensleri [6.5 x 9 mm]

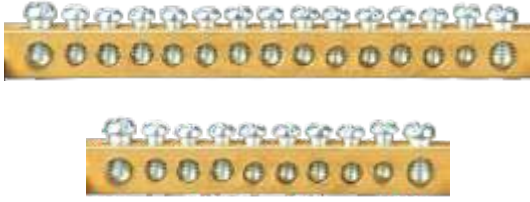

KOD	CİNSİ		KUTU ADET	ADET TL
V00001X	5 Del. Pano Top. Klm.	80 Amp.	50	36,50
V00002X	7 Del. Pano Top. Klm.	80 Amp.	50	45,40
V00003X	10 Del. Pano Top. Klm.	80 Amp.	50	63,50
V00008X	12 Del. Pano Top. Klm.	80 Amp.	50	77,15
V00009X	15 Del. Pano Top. Klm.	80 Amp.	50	109,55
V00004X	20 Del. Pano Top. Klm.	80 Amp.	20	160,00
V00010X	30 Del. Pano Top. Klm.	80 Amp.	20	273,35
V00005X	40 Del. Pano Top. Klm.	80 Amp.	20	410,75
V00006X	60 Del. Pano Top. Klm.	80 Amp.	10	595,25
V00007X	80 Del. Pano Top. Klm.	80 Amp.	10	797,65

Kablo Kesiti 16 mm²

Ayaklı Pano Topraklama Klemensleri [6.5 x 9 mm]



KOD	CİNSİ		KUTU ADET	ADET TL
V00051X	5 Del. Pano Top. Klm. Ayaklı	80 Amp.	50	63,50
V00052X	7 Del. Pano Top. Klm. Ayaklı	80 Amp.	50	79,40
V00053X	10 Del. Pano Top. Klm. Ayaklı	80 Amp.	50	96,50
V00054X	12 Del. Pano Top. Klm. Ayaklı	80 Amp.	50	104,30
V00059X	15 Del. Pano Top. Klm. Ayaklı	80 Amp.	50	124,30
V00055X	20 Del. Pano Top. Klm. Ayaklı	80 Amp.	20	164,30
V00060X	30 Del. Pano Top. Klm. Ayaklı	80 Amp.	20	308,60
V00056X	40 Del. Pano Top. Klm. Ayaklı	80 Amp.	20	436,50
V00057X	60 Del. Pano Top. Klm. Ayaklı	80 Amp.	10	615,50
V00058X	80 Del. Pano Top. Klm. Ayaklı	80 Amp.	10	821,80

Kablo Kesiti 16 mm²

Pano Topraklama Klemensleri [7 x 12 mm]

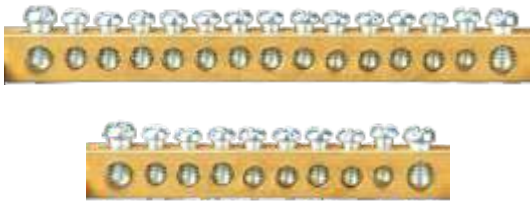

KOD	CİNSİ		KUTU ADET	ADET TL
V00021X	5 Del. Pano Top. Klm.	125 Amp.	50	95,30
V00022X	7 Del. Pano Top. Klm.	125 Amp.	50	115,90
V00023X	10 Del. Pano Top. Klm.	125 Amp.	50	139,30
V00024X	12 Del. Pano Top. Klm.	125 Amp.	50	162,70
V00025X	15 Del. Pano Top. Klm.	125 Amp.	50	214,30
V00026X	20 Del. Pano Top. Klm.	125 Amp.	20	257,20
V00030X	30 Del. Pano Top. Klm.	125 Amp.	20	471,45
V00027X	40 Del. Pano Top. Klm.	125 Amp.	20	635,00
V00028X	60 Del. Pano Top. Klm.	125 Amp.	10	953,00
V00029X	80 Del. Pano Top. Klm.	125 Amp.	10	1.270,00

Kablo Kesiti 25 mm²

Ayaklı Pano Topraklama Klemensleri 125 Amp. [7 x 12 mm]

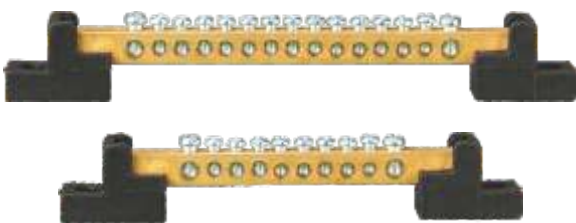

KOD	CİNSİ		KUTU ADET	ADET TL
V00071X	5 Del. Pano Top. Klm. Ayaklı	125 Amp.	50	110,80
V00072X	7 Del. Pano Top. Klm. Ayaklı	125 Amp.	50	130,80
V00073X	10 Del. Pano Top. Klm. Ayaklı	125 Amp.	50	155,80
V00074X	12 Del. Pano Top. Klm. Ayaklı	125 Amp.	50	183,70
V00079X	15 Del. Pano Top. Klm. Ayaklı	125 Amp.	50	243,30
V00075X	20 Del. Pano Top. Klm. Ayaklı	125 Amp.	20	282,20
V00080X	30 Del. Pano Top. Klm. Ayaklı	125 Amp.	20	520,50
V00076X	40 Del. Pano Top. Klm. Ayaklı	125 Amp.	20	683,00
V00077X	60 Del. Pano Top. Klm. Ayaklı	125 Amp.	10	995,00
V00078X	80 Del. Pano Top. Klm. Ayaklı	125 Amp.	10	1320,50

Kablo Kesiti 25 mm²

Pano Topraklama Klemensleri 160 Amp. [10 x 15mm]

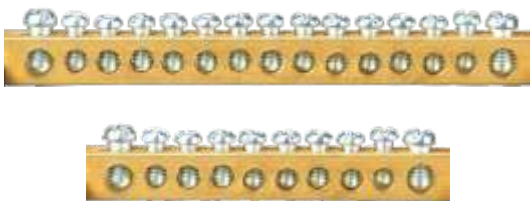

KOD	CİNSİ		KUTU ADET	ADET TL
V00101X	5 Del. Pano Top. Klm.	160 Amp.	50	296,60
V00102X	7 Del. Pano Top. Klm.	160 Amp.	50	387,90
V00103X	10 Del. Pano Top. Klm.	160 Amp.	50	502,00
V00104X	12 Del. Pano Top. Klm.	160 Amp.	50	547,70
V00105X	15 Del. Pano Top. Klm.	160 Amp.	50	707,40
V00106X	20 Del. Pano Top. Klm.	160 Amp.	20	949,20
V00107X	30 Del. Pano Top. Klm.	160 Amp.	20	1.300,00
V00108X	40 Del. Pano Top. Klm.	160 Amp.	20	1.802,50
V00109X	60 Del. Pano Top. Klm.	160 Amp.	10	1.871,00
V00110X	80 Del. Pano Top. Klm.	160 Amp.	10	2.054,00

Kablo Kesiti 50 mm²

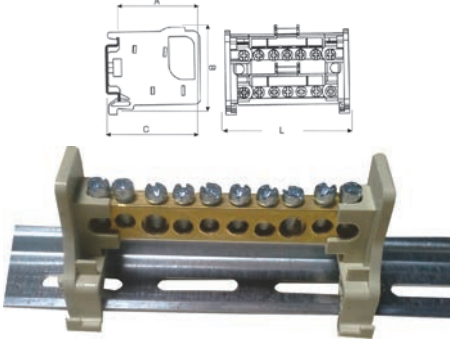
Ray Tipi Kapaksız 1 Kutuplu 80 A. Terminaller [6.5 x 9 mm]

KOD	cİNSİ	L	B	C	A	KUTU ADET	ADET TL
U00081X	5 Delikli 1 Kutuplu Terminal	58	44	44	42	90	146,90
U00082X	7 Delikli 1 Kutuplu Terminal	60	44	44	42	70	161,90
U00083X	10 Delikli 1 Kutuplu Terminal	82	44	44	42	65	177,00
U00084X	12 Delikli 1 Kutuplu Terminal	100	44	44	42	55	208,75
U00085X	15 Delikli 1 Kutuplu Terminal	115	44	44	42	45	230,00
U00086X	22 Delikli 1 Kutuplu Terminal	155	44	44	42	30	365,00

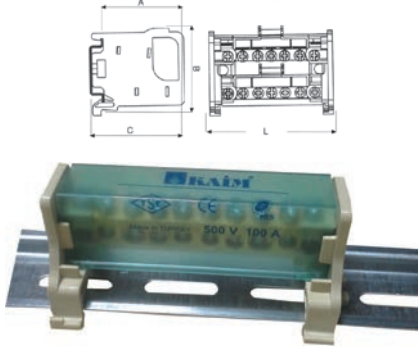
Kablo Kesiti 16 mm²
Ray Geniřliđi 35
Ray Tipi Kapaklı 1 Kutuplu 80 A. Terminaller [6.5 x 9 mm]

KOD	cİNSİ	L	B	C	A	KUTU ADET	ADET TL
U00091X	5 Delikli 1 Kutuplu Terminal	58	44	44	42	80	154,80
U00092X	7 Delikli 1 Kutuplu Terminal	60	44	44	42	60	172,20
U00093X	10 Delikli 1 Kutuplu Terminal	82	44	44	42	55	190,00
U00094X	12 Delikli 1 Kutuplu Terminal	100	44	44	42	45	223,60
U00095X	15 Delikli 1 Kutuplu Terminal	115	44	44	42	35	259,60
U00096X	22 Delikli 1 Kutuplu Terminal	155	44	44	42	25	387,50

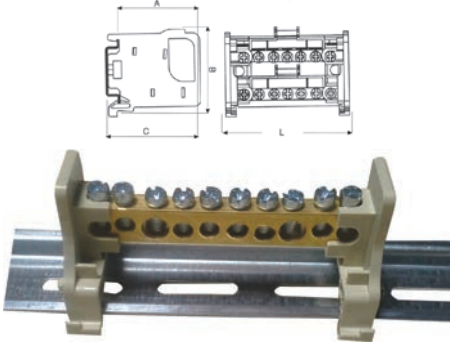
Kablo Kesiti 16 mm²
Ray Geniřliđi 35
Ray Tipi Kapaksız 1 Kutuplu 125 A. Terminaller [7 x 12 mm]

KOD	cİNSİ	L	L	L	L	KUTU ADET	ADET TL
U00121X	5 Delikli 1 Kutuplu Terminal	72	44	44	42	80	161,50
U00122X	7 Delikli 1 Kutuplu Terminal	76	44	44	42	65	178,10
U00123X	10 Delikli 1 Kutuplu Terminal	100	44	44	42	48	194,70
U00124X	12 Delikli 1 Kutuplu Terminal	115	44	44	42	45	229,00
U00125X	15 Delikli 1 Kutuplu Terminal	135	44	44	42	40	285,70
U00126X	22 Delikli 1 Kutuplu Terminal	185	44	44	42	30	393,65

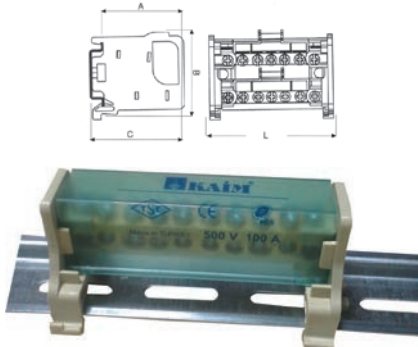
Kablo Kesiti 25mm²
Ray Geniřliđi 35
Ray Tipi Kapaklı 1 Kutuplu 125 A. Terminaller [7 x 12 mm]

KOD	cİNSİ	L	L	L	L	KUTU ADET	ADET TL
U00131X	5 Delikli 1 Kutuplu Terminal	72	44	44	42	70	171,30
U00132X	7 Delikli 1 Kutuplu Terminal	76	44	44	42	50	187,40
U00133X	10 Delikli 1 Kutuplu Terminal	100	44	44	42	40	203,50
U00134X	12 Delikli 1 Kutuplu Terminal	115	44	44	42	40	240,00
U00135X	15 Delikli 1 Kutuplu Terminal	135	44	44	42	30	305,00
U00136X	22 Delikli 1 Kutuplu Terminal	185	44	44	42	20	419,00

Kablo Kesiti 25 mm²
Ray Geniřliđi 35

Ray Tipi Kapaksız 1 Kutuplu 160 A. Terminaller (10 x 15 mm)

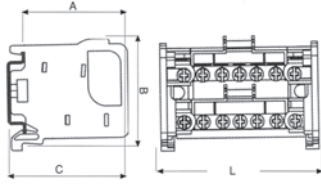

KOD	Cinsi	L	B	C	A	KUTU ADET	ADET TL
U00341X	5 Delikli 1 Kutuplu Terminal	72	44	44	42	80	289,70
U00342X	7 Delikli 1 Kutuplu Terminal	76	44	44	42	65	389,00
U00343X	10 Delikli 1 Kutuplu Terminal	100	44	44	42	48	484,50
U00344X	12 Delikli 1 Kutuplu Terminal	115	44	44	42	45	563,50
U00345X	15 Delikli 1 Kutuplu Terminal	135	44	44	42	40	674,60
U00346X	22 Delikli 1 Kutuplu Terminal	185	44	44	42	30	948,50

Kablo Kesiti 35 mm² - 50 mm²

Ray Geniřliđi 35

2 Kutuplu 80 A. Terminaller (6,5 x 9 mm)

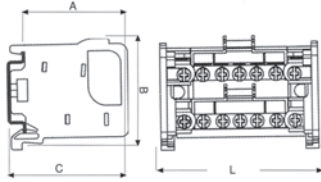

KOD	Cinsi	L	B	C	A	KUTU ADET	ADET TL
U00107X	5 Delikli 2 Kutuplu Terminal	48	47	48	43	36	212,00
U00101X	7 Delikli 2 Kutuplu Terminal	57	47	48	43	24	222,60
U00102X	10 Delikli 2 Kutuplu Terminal	76	47	48	43	18	279,60
U00103X	12 Delikli 2 Kutuplu Terminal	89	47	48	43	14	328,00
U00104X	15 Delikli 2 Kutuplu Terminal	109	47	48	43	12	375,00
U00105X	22 Delikli 2 Kutuplu Terminal	154	47	48	43	10	503,00

Kablo Kesiti 10 mm² - 16 mm²

Ray Geniřliđi 35

2 Kutuplu 125 A. Terminaller (7 x 12 mm)

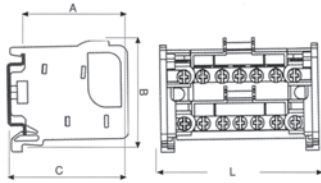

KOD	Cinsi	L	B	C	A	KUTU ADET	ADET TL
U00117X	5 Delikli 2 Kutuplu Terminal	54	47	48	43	36	270,20
U00111X	7 Delikli 2 Kutuplu Terminal	63	47	48	43	24	298,70
U00112X	10 Delikli 2 Kutuplu Terminal	85	47	48	43	18	407,30
U00113X	12 Delikli 2 Kutuplu Terminal	100	47	48	43	14	471,60
U00114X	15 Delikli 2 Kutuplu Terminal	123	47	48	43	12	577,00
U00115X	22 Delikli 2 Kutuplu Terminal	173	47	48	43	10	717,00

Kablo Kesiti 25 mm² - 16 mm²

Ray Geniřliđi 35

Yüksek Tip 3 Kutuplu 125 A. Terminaller (7 x 12 mm)

KOD	cinsi	L	B	C	A	KUTU ADET	ADET TL
U00151X	5 Delikli 3 Kutuplu Terminal	54	75	76	71	14	428,50
U00152X	7 Delikli 3 Kutuplu Terminal	63	75	76	71	10	521,00
U00153X	10 Delikli 3 Kutuplu Terminal	85	75	76	71	8	650,70
U00154X	12 Delikli 3 Kutuplu Terminal	100	75	76	71	6	755,00
U00155X	15 Delikli 3 Kutuplu Terminal	123	75	76	71	5	934,00
U00156X	22 Delikli 3 Kutuplu Terminal	173	75	76	71	4	1.282,00

Kablo Kesiti 25 mm² - 16 mm²
Ray Geniřliđi 35
Yassı Tip 3 Kutuplu 125 A. Terminaller (7 x 12 mm)

KOD	cinsi	L	B	C	A	KUTU ADET	ADET TL
U00141X	5 Delikli 3 Kutuplu Terminal	87	95	55	60	20	428,60
U00142X	7 Delikli 3 Kutuplu Terminal	105	95	55	60	14	519,90
U00143X	10 Delikli 3 Kutuplu Terminal	145	95	55	60	12	646,90
U00144X	12 Delikli 3 Kutuplu Terminal	165	95	55	60	10	750,00
U00145X	15 Delikli 3 Kutuplu Terminal	200	95	55	60	9	924,600
U00146X	22 Delikli 3 Kutuplu Terminal	275	95	55	60	6	1.265,90

Kablo Kesiti 25 mm² - 16 mm²
Ray Geniřliđi 35 - Perpa Saclı Panolarda Kullanılır.
Yüksek Tip 4 Kutuplu 125 A. Terminaller (7 x 12 mm)

KOD	cinsi	L	B	C	A	KUTU ADET	ADET TL
U00171X	5 Delikli 4 Kutuplu Terminal	54	75	76	71	14	539,40
U00172X	7 Delikli 4 Kutuplu Terminal	63	75	76	71	10	655,00
U00173X	10 Delikli 4 Kutuplu Terminal	85	75	76	71	8	816,00
U00174X	12 Delikli 4 Kutuplu Terminal	100	75	76	71	6	947,00
U00175X	15 Delikli 4 Kutuplu Terminal	123	75	76	71	5	1.169,00
U00176X	22 Delikli 4 Kutuplu Terminal	173	75	76	71	4	1.602,00

Kablo Kesiti 25 mm² - 16 mm²
Ray Geniřliđi 35
Yassı Tip 4 Kutuplu 125 A. Terminaller (7 x 12 mm)

KOD	cinsi	L	B	C	A	KUTU ADET	ADET TL
U00161X	5 Delikli 4 Kutuplu Terminal	87	125	55	60	14	555,70
U00162X	7 Delikli 4 Kutuplu Terminal	105	125	55	60	10	638,60
U00163X	10 Delikli 4 Kutuplu Terminal	145	125	55	60	8	804,50
U00164X	12 Delikli 4 Kutuplu Terminal	165	125	55	60	7	913,40
U00165X	15 Delikli 4 Kutuplu Terminal	200	125	55	60	6	1.112,00
U00166X	22 Delikli 4 Kutuplu Terminal	275	125	55	60	4	1.462,80

Kablo Kesiti 25 mm² - 16 mm²
Ray Geniřliđi 35 - Perde Saclı Panolarda Kullanılır.
Yassı Tip 5 Kutuplu 125 A. Terminaller (7 x 12 mm)

KOD	cinsi	L	B	C	A	KUTU ADET	ADET TL
U00181X	5 Delikli 5 Kutuplu Terminal	87	155	55	60	12	659,00
U00182X	7 Delikli 5 Kutuplu Terminal	105	155	55	60	10	770,50
U00183X	10 Delikli 5 Kutuplu Terminal	145	155	55	60	7	1.009,50
U00184X	12 Delikli 5 Kutuplu Terminal	165	155	55	60	6	1.111,60
U00185X	15 Delikli 5 Kutuplu Terminal	200	155	55	60	5	1332,70
U00186X	22 Delikli 5 Kutuplu Terminal	275	155	55	60	4	1.823,00

Kablo Kesiti 25 mm² - 16 mm²
Ray Geniřliđi 35 - Perde Saclı Panolarda Kullanılır.

Ray Tipi 1 Kutuplu 160 A. Terminaller (10 x 15 mm)



KOD	CİNSİ	L	B	C	A	KUTU ADET	ADET TL
U00351X	5 Delikli 1 Kutuplu Terminal	72	44	44	42	70	372,60
U00352X	7 Delikli 1 Kutuplu Terminal	76	44	44	42	50	483,70
U00353X	10 Delikli 1 Kutuplu Terminal	100	44	44	42	40	568,00
U00354X	12 Delikli 1 Kutuplu Terminal	115	44	44	42	40	715,65
U00355X	15 Delikli 1 Kutuplu Terminal	135	44	44	42	30	895,00
U00356X	22 Delikli 1 Kutuplu Terminal	185	44	44	42	20	937,00

Kablo Kesiti 50 mm²

Ray Geniřliđi 35

2 Kutuplu 160 A. Terminaller (10 x 15 mm)

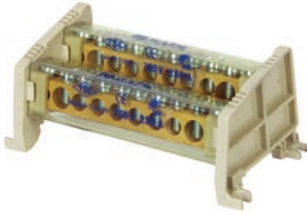

KOD	CİNSİ	L	B	C	A	KUTU ADET	ADET TL
U00301X	5 Delikli 2 Kutuplu Terminal	87	95	55	60	20	599,50
U00302X	7 Delikli 2 Kutuplu Terminal	105	95	55	60	14	704,00
U00303X	10 Delikli 2 Kutuplu Terminal	145	95	55	60	12	890,50
U00304X	12 Delikli 2 Kutuplu Terminal	165	95	55	60	10	983,40
U00305X	15 Delikli 2 Kutuplu Terminal	200	95	55	60	9	1.176,50
U00306X	22 Delikli 2 Kutuplu Terminal	275	95	55	60	6	1.692,00

Kablo Kesiti 50 mm²

Ray Geniřliđi 35

3 Kutuplu 160 A. Terminaller (10 x 15 mm)



KOD	CİNSİ	L	B	C	A	KUTU ADET	ADET TL
U00311X	5 Delikli 3 Kutuplu Terminal	87	95	55	60	20	758,00
U00312X	7 Delikli 3 Kutuplu Terminal	105	95	55	60	14	999,00
U00313X	10 Delikli 3 Kutuplu Terminal	145	95	55	60	12	1.360,00
U00314X	12 Delikli 3 Kutuplu Terminal	165	95	55	60	10	1.510,00
U00315X	15 Delikli 3 Kutuplu Terminal	200	95	55	60	9	1.677,00
U00316X	22 Delikli 3 Kutuplu Terminal	275	95	55	60	6	2.421,00

Kablo Kesiti 50 mm²

Ray Geniřliđi 35

4 Kutuplu 160 A. Terminaller (10 x 15 mm)



KOD	CİNSİ	L	B	C	A	KUTU ADET	ADET TL
U00321X	5 Delikli 4 Kutuplu Terminal	87	125	55	60	14	1.044,00
U00322X	7 Delikli 4 Kutuplu Terminal	105	125	55	60	10	1.416,00
U00323X	10 Delikli 4 Kutuplu Terminal	145	125	55	60	8	1.768,00
U00324X	12 Delikli 4 Kutuplu Terminal	165	125	55	60	7	2.050,00
U00325X	15 Delikli 4 Kutuplu Terminal	200	125	55	60	6	2.472,00
U00326X	22 Delikli 4 Kutuplu Terminal	275	125	55	60	4	3.478,00

Kablo Kesiti 50 mm²

Ray Geniřliđi 35

5 Kutuplu 160 A. Terminaller (10 x 15 mm)



KOD	CİNSİ	L	B	C	A	KUTU ADET	ADET TL
U00331X	5 Delikli 5 Kutuplu Terminal	87	155	55	60	12	1.424,00
U00332X	7 Delikli 5 Kutuplu Terminal	105	155	55	60	10	1.747,00
U00333X	10 Delikli 5 Kutuplu Terminal	145	155	55	60	7	2.172,00
U00334X	12 Delikli 5 Kutuplu Terminal	165	155	55	60	6	2.553,00
U00335X	15 Delikli 5 Kutuplu Terminal	200	155	55	60	5	3.056,00
U00336X	22 Delikli 5 Kutuplu Terminal	275	155	55	60	4	4.363,00

Kablo Kesiti 50 mm²

Ray Geniřliđi 35

3 Kutuplu Trifaze W Otomat Baraları

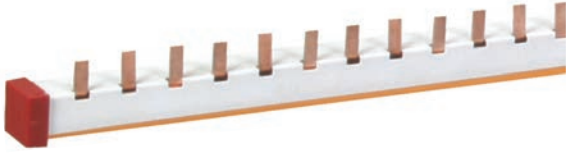

Kalınlık 1 mm Akım Taşıma Kesiti 9 mm²

KOD	cinsi	KUTU ADET	ADET TL
P00020F	3 Modül 16 cm 3 Kutuplu (63 Amp.)	25	270,90
P00023F	4 Modül 21 cm 3 Kutuplu (63 Amp.)	25	360,00
P00026F	5 Modül 26 cm 3 Kutuplu (63 Amp.)	25	450,50
P00017F	10 Modül 52 cm 3 Kutuplu (63 Amp.)	25	899,90
P00013F	20 Modül 104 cm 3 Kutuplu (63 Amp.)	20	1.799,00

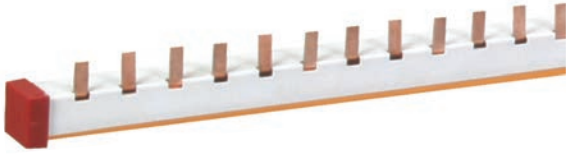

Kalınlık 1,25 mm Akım Taşıma Kesiti 11 mm²

KOD	cinsi	KUTU ADET	ADET TL
P00021F	3 Modül 16 cm 3 Kutuplu (80 Amp.)	25	349,50
P00024F	4 Modül 21 cm 3 Kutuplu (80 Amp.)	25	466,80
P00027F	5 Modül 26 cm 3 Kutuplu (80 Amp.)	25	583,00
P00002F	10 Modül 52 cm 3 Kutuplu (80 Amp.)	25	1.165,00
P00012F	20 Modül 104 cm 3 Kutuplu (80 Amp.)	20	2.330,00

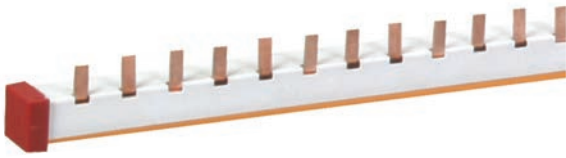

Kalınlık 1,50 mm Akım Taşıma Kesiti 13,50 mm²

KOD	cinsi	KUTU ADET	ADET TL
P00022F	3 Modül 16 cm 3 Kutuplu (100 Amp.)	25	431,00
P00025F	4 Modül 21 cm 3 Kutuplu (100 Amp.)	25	574,60
P00028F	5 Modül 26 cm 3 Kutuplu (100 Amp.)	25	718,00
P00016F	10 Modül 52 cm 3 Kutuplu (100 Amp.)	25	1.436,50
P00015F	20 Modül 104 cm 3 Kutuplu (100 Amp.)	20	2.872,00

2 Kutuplu [Dufaze] W Otomat Baraları

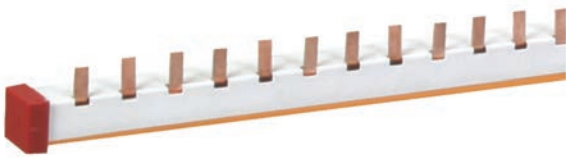

Kalınlık 1,25 mm Akım Taşıma Kesiti 11 mm²

KOD	cinsi	KUTU ADET	ADET TL
P00010F	İğne Tip 14 Modül (80 Amp.)	30	838,40



KOD	cinsi	KUTU ADET	ADET TL
P00014F	Müşterek W Otomat Bara Nihayet Kapağı Sağ	160	6,60
P00014F	Müşterek W Otomat Bara Nihayet Kapağı Sol	160	6,60

3 Faz + Nötr Kesmeli W Otomat Baraları

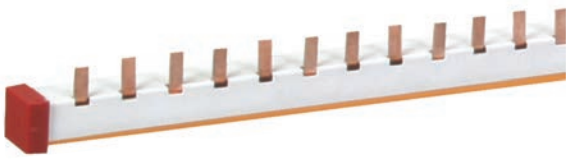

Kalınlık 1,50 mm Akım Taşıma Kesiti 13,5 mm²

KOD	cinsi	KUTU ADET	ADET TL
P00033F	8 Modül 3 Faz + Nötr (100 Amp.)	25	Sorunuz
P00034F	14 Modül 3 Faz + Nötr (100 Amp.)	25	Sorunuz

Monofaze W Otomat Baraları



Kalınlık 1 mm Akım Taşıma Kesiti 9 mm²



Kalınlık 1,25 mm Akım Taşıma Kesiti 11 mm²



Kalınlık 1,50 mm Akım Taşıma Kesiti 13,5 mm²

KOD	cinsi	KUTU ADET	ADET TL
P00006F	56 Modül 1 mt 15x1 mm İzoleli [63 Amp.]	30	508,25
P00007F	56 Modül 1 mt 15x1.25 mm İzoleli [80Amp.]	30	648,50
P00008F	56 Modül 1 mt 15x1,50 mm İzoleli [100 Amp.]	30	788,50
P00004F	Monofaze Bara Nihayet Kapağı Sağ	100	3,95
P00005F	Monofaze Bara Nihayet Kapağı Sol	100	3,95

Nötr Topraklama Baraları



KOD	cinsi	KUTU ADET	ADET TL
N00005F	15x1.5 mm Top. Barası 1 mt [31 Papuç]	20	789,00
N00001F	15x2 mm Top. Barası 1 mt [31 Papuç]	20	965,80
N00003F	15x3 mm Top. Barası 1 mt [31 Papuç]	10	1.437,00
N00006F	15x1.5 mm Top. Barası 1 mt [62 Papuç]	20	951,00
N00002F	15x2 mm Top. Barası 1 mt [62 Papuç]	20	1.104,00
N00007F	15x3 mm Top. Barası 1 mt [62 Papuç]	10	1.560,00

Nötr Topraklama Bara Aksesuarları



N00008F N00004F N00040X-41X

KOD	cinsi	KUTU ADET	ADET TL
N00030F	Papuç Takımı	500	6,95
N00004F	Bara Mesnedi h: 25 mm	160	15,25

KOD	cinsi	KUTU ADET	ADET TL
N00040X	16 mm Bara Bağlantı Klemensi	300	Sorunuz
N00041X	35 mm Bara Bağlantı Klemensi	250	Sorunuz
N00008F	12x3.5 mm Pirinç Top. Barası 1 mt [Düz]	10	Sorunuz
N00025F	10x3 mm Pirinç Top. Barası 1 mt [Düz]	10	Sorunuz

Ürünlere kaplama yapılmıştır.

Kanca Tipi Bağlantı Klemensleri Yay Baskılı

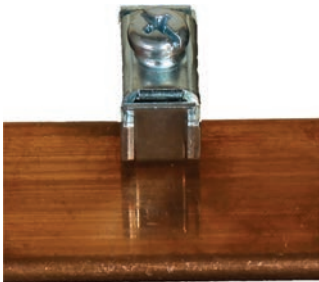

KOD	KABLO KESİTİ	BARA KALINLIĞI	cinsi	KUTU ADET	ADET TL
N00045X	16 mm	5 mm	Kanca Bağlantı Klemensi	100	Sorunuz
N00046X	16 mm	10 mm	Kanca Bağlantı Klemensi	100	Sorunuz
N00047X	35 mm	5 mm	Kanca Bağlantı Klemensi	50	Sorunuz
N00048X	35 mm	10 mm	Kanca Bağlantı Klemensi	50	Sorunuz
N00049X	70 mm	5 mm	Kanca Bağlantı Klemensi	25	Sorunuz
N00050X	70 mm	10 mm	Kanca Bağlantı Klemensi	25	Sorunuz
N00051X	120 mm	5 mm	Kanca Bağlantı Klemensi	25	Sorunuz
N00052X	120 mm	10 mm	Kanca Bağlantı Klemensi	25	Sorunuz

Sac Delikli W Otomat Rayları 35x7.5

KOD	cinsi	KUTU ADET	ADET TL
L00060F	Sac Delikli W Otomat Rayı [30 cm] h: 7.5	100	31,50
L00061F	Sac Delikli W Otomat Rayı [1 mt] h: 7.5	60	91,60
L00062F	Sac Delikli W Otomat Rayı [2 mt] h: 7.5	30	183,00

1 mm Galvanizli Sacdan Üretilmiştir

Alüminyum Delikli W Otomat Rayları

KOD	cinsi	KUTU ADET	ADET TL
L00011F	Delikli W Otomat Rayı [30 cm] h: 7.5	60	65,90
L00012F	Delikli W Otomat Rayı [1 mt] h: 7.5	60	215,70

35x7,5



KOD	cinsi	KUTU ADET	ADET TL
L00015F	Delikli MG Tip Ray [1 mt] h: 15	36	416,50
L00050F	Delikli Yüksek W Otomat Rayı [30 cm] h: 15	100	162,00
L00051F	Delikli Yüksek W Otomat Rayı [1 mt] h: 15	60	524,90
L00052F	Delikli Yüksek W Otomat Rayı [2 mt] h: 15	30	1.031,00

35x15

Ray Taşıyıcılar - Kroşe Rayı ve Kroşeler

KOD	cinsi	KUTU ADET	ADET TL
L00010F	Ray Taşıyıcı h: 36 Küçük Eğik	200	38,20
L00028F	Ray Taşıyıcı h: 60 Büyük Eğik	100	49,75
L00026F	Kroşe Rayı [1mt]	90	149,50
S00005F	No: 1 Kroşe [2x1,5 - 4x2,5]	350	10,90
S00006F	No: 2 Kroşe [4x4 - 4x16]	250	11,90
L00027F	Kmp. Şlt. Bağlantı Klemensi M4-M5-M6-M8	100	-

Kablo Taşıma Rayı

KOD	cinsi	KUTU ADET	ADET TL
L00029F	Kablo Taşıma Rayı Alm. 1 mt Düz	50	637,90

Tandır Kroşeler

KOD	cinsi	KUTU ADET	ADET TL
T00001X	No: 1 Tandır Kroşe [2x1,5 - 2x6]	500	-
T00002X	No: 2 Tandır Kroşe [4x6]	500	-
T00003X	No: 3 Tandır Kroşe [4x10]	400	-
T00004X	No: 4 Tandır Kroşe [4x16]	300	-
T00005X	No: 5 Tandır Kroşe [3x25 + 16]	250	-

Mesnet İzolatörleri



	KOD	CİNSİ		YÜKSEKLİK	KUTU ADET	ADET TL
FIÇI	H00020X	Mini Boy	M5 2C	h: 25	250	31,70
	H00029X	Mini Boy	M5 1S+1C	h: 25	250	39,85
	H00030X	Mini Boy	M5 2S	h: 25	250	47,95
KONİK	H00031X	Orta Boy	M6 2C	h: 27	100	42,80
	H00032X	Orta Boy	M6 1S+1C	h: 27	100	47,95
	H00033X	Orta Boy	M6 2S	h: 27	100	52,90
FIÇI	H00021X	Orta Boy	M8 2C	h: 35	50	53,10
	H00034X	Orta Boy	M8 1S+1C	h: 35	50	59,75
	H00027X	Orta Boy	M8 2S	h: 35	50	66,40
FIÇI	H00035X	Büyük Boy	M8 2C	h: 40	40	73,75
	H00036X	Büyük Boy	M8 1S+1C	h: 40	40	81,15
	H00037X	Büyük Boy	M8 2S	h: 40	40	88,50
	H00022X	Büyük Boy	M10 2C	h: 40	40	103,35
	H00038X	Büyük Boy	M10 1S+1C	h: 40	40	106,20
FIÇI	H00028X	Büyük Boy	M10 2S	h: 40	40	108,40
	H00075X	Büyük Boy	M10 2C	h: 50	20	136,45
	H00076X	Büyük Boy	M10 1S+1C	h: 50	20	132,75
	H00077X	Büyük Boy	M10 2S	h: 50	20	121,70
	H00039X	1 NK İzolatörü 2S	M16		12	243,40
	H00090X	IN. 500 Mesnet İzolatörü	M12		20	202,85
	H00091X	IN. 500 Mesnet İzolatörü	M10		20	173,50
	H00092X	IN. 1000 Mesnet İzolatörü	M12		10	420,50
	H00093X	IN. 1000 Mesnet İzolatörü	M16		10	553,15

Tarak İzolatörleri



KOD	CİNSİ	KUTU ADET	ADET TL
H00023X	DBT 3x1 F Tarak İzolatör Uzun Tip	40	125,40
H00024X	DBT 3x1 F Tarak İzolatör Kısa Tip	20	95,20
H00025X	DBT 3x2 F Tarak İzolatör	40	132,80
H00040X	DBT 3x1 F+Nötr Tarak İzolatör	40	132,80
H00041X	DBT 3x2 F+Nötr Tarak İzolatör	8	180,70

Bara Serfilleri

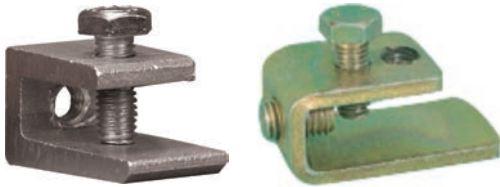

KOD	CİNSİ	KUTU ADET	ADET TL
B00049F	M6 Alüminyum Gövde	140	46,20
B00050F	M8 Alüminyum Gövde	140	46,20
B00054F	M8 ST. 37 Sarı Kaplama	75	71,90
B00051F	M10 ST. 37 Sarı Kaplama	75	71,90
B00052F	M12 ST. 37 Sarı Kaplama	75	76,20
B00053F	M14 ST. 37 Sarı Kaplama	75	78,10

Motor Klemensleri

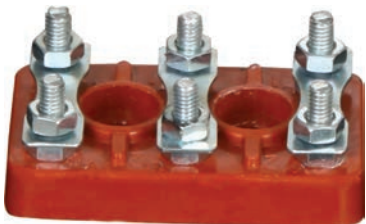

KOD	CİNSİ	KUTU ADET	ADET TL
H00061X	No: 1 M4 Vidalı Motor Klemensi	100	-
H00062X	No: 2 M4A Vidalı Motor Klemensi	100	-
H00063X	No: 3 M5 Vidalı Motor Klemensi	100	-
H00064X	No: 4 M6 Vidalı Motor Klemensi	48	-
H00065X	No: 5 M8 Vidalı Motor Klemensi	36	-
H00066X	No: 6 M10 Vidalı Motor Klemensi	32	-
H00067X	No: 7 M12 Vidalı Motor Klemensi	12	-
H00068X	No: 8 M16 Vidalı Motor Klemensi	12	-

Sac Tabanlı Mat Kapaklı ABS Panolar

KOD	cinsi	KUTU ADET	ADET TL
Z01371F	160x250x110 Taban Saclı (ABS) Vidalı	6	656,00
Z01372F	180x270x100 Taban Saclı (ABS) Vidalı	3	745,00
Z01373F	180x270x140 Taban Saclı (ABS) Vidalı	2	825,00
Z01374F	250x330x110 Taban Saclı (ABS) Kilitli	1	1.338,00
Z01375F	250x350x150 Taban Saclı (ABS) Kilitli IP65	1	1.672,00
Z01386X	300x400x170 Taban Saclı (ABS) Kilitli IP65	1	1.342,00
Z01387X	400x500x180 Taban Saclı (ABS) Kilitli IP65	1	2.180,00
Z01390X	400x600x200 Taban Saclı (ABS) Kilitli IP65	1	2.530,00
Z01388X	500x700x250 Taban Saclı (ABS) Kilitli IP65	1	3.990,00

ABS Malzemedен Üretilmiştir

Sac Tabanlı Şeffaf Kapaklı ABS Panolar

KOD	cinsi	KUTU ADET	ADET TL
Z01377F	160x250x110 Taban Saclı (ABS) Vidalı	6	725,00
Z01378F	180x270x100 Taban Saclı (ABS) Vidalı	3	818,00
Z01379F	180x270x140 Taban Saclı (ABS) Vidalı	2	908,00
Z01380F	250x330x110 Taban Saclı (ABS) Kilitli	1	1.471,00
Z01381F	250x350x150 Taban Saclı (ABS) Kilitli IP65	1	1.825,00
Z01382X	300x400x170 Taban Saclı (ABS) Kilitli IP65	1	1.610,00
Z01383X	400x500x180 Taban Saclı (ABS) Kilitli IP65	1	2.615,00
Z01396X	400x600x200 Taban Saclı (ABS) Kilitli IP65	1	3.160,00
Z01384X	500x700x250 Taban Saclı (ABS) Kilitli IP65	1	4.985,00

Gövde: ABS Malzeme / Cam: Polikarbon

Polyester Alev Yayımaz Panolar

KOD	cinsi	İÇ HACMİ	KUTU ADET	ADET TL
280160X	25x30x17 Taban Saclı Polyester Kilitli	20x27x14	1	2.405,00
280161X	30x40x18 Taban Saclı Polyester Kilitli	25x37x14	1	3.222,00
280162X	40x50x19 Taban Saclı Polyester Kilitli	36x47x15	1	4.625,00
280164X	40x60x20 Taban Saclı Polyester Kilitli	36x57x16	1	5.206,00
280163X	50x70x22 Taban Saclı Polyester Kilitli	45x67x17	1	9.760,00

KOD	cinsi	KUTU ADET	ADET TL
280166X	30x40x18 Perde Saclı 20 Otomat+Pako Şalter Kullanılabilir	1	6.174,00
280167X	40x50x19 Perde Saclı 45 Otomat+Pako Şalter Kullanılabilir	1	8.396,00
280168X	50x70x22 Perde Saclı 80 Otomat+Pako Şalter Kullanılabilir	1	15.103,00

**Monoblok Gövde
Sac Tabanlı**



Z01470X	150x230 mm Yapışkan Ölüm Tehlikesi	100	Sorunuz
---------	------------------------------------	-----	---------

ABS Şeffaf Kapaklı - Perdeli Sac Tabanlı Otomat Kutuları

IP55



KOD	cinsi	KUTU ADET	ADET TL
Z01421F	9'lu 1 Sıralı Dikey S/Ü [180x270x100]	3	1.184,00
Z01422F	14'lü 1 Sıralı Dikey S/Ü [270x180x100]	3	1.215,00
Z01423F	17'li 1 Sıralı Dikey S/Ü [330x250x110]	1	1.692,00
Z01424F	26'lı 2 Sıralı Dikey S/Ü [250x330x110]	1	1.894,00
Z01426X	50'li 3 Sıralı Dikey S/Ü [400x500x200]	1	5.150,00
Z01427X	60'lı 4 Sıralı Dikey S/Ü [400x600x200]	1	5.720,00

Gövde: ABS / Cam: Polikarbon

ABS Mat Kapaklı - Perdeli Sac Tabanlı Otomat Kutuları

IP55



KOD	cinsi	KUTU ADET	ADET TL
Z01411F	9'lu 1 Sıralı Dikey S/Ü [180x270x100]	3	1.126,00
Z01412F	14'lü 1 Sıralı Yatay S/Ü [270x180x100]	3	1.152,00
Z01413F	17'li 1 Sıralı Yatay S/Ü [330x250x110]	1	1.676,00
Z01414F	26'lı 2 Sıralı Dikey S/Ü [250x330x110]	1	1.806,00
Z01416X	50'li 3 Sıralı Dikey S/Ü [400x500x200]	1	4.370,00
Z01417X	60'lı 4 Sıralı Dikey S/Ü [400x600x200]	1	4.590,00

ABS Malzemeden Üretilmiştir

Sac Tabanlı - Mat ve Şeffaf Kapaklı Termo Pls. Sigorta Kutulu Panolar

IP54



KOD	cinsi	KUTU ADET	ADET TL
Z01391F	250x500x110 Taban Saçlı (ABS) Mat Kapak	1	2.313,00
Z01392F	250x500x145 Taban Saçlı (ABS) Mat Kapak	1	2.505,00

KOD	cinsi	KUTU ADET	ADET TL
Z01393F	250x500x110 Taban Saçlı (ABS) Şeffaf Kpk.	1	2.507,00
Z01394F	250x500x145 Taban Saçlı (ABS) Şeffaf Kpk.	1	2.620,00

Gövde: ABS / Cam: Polikarbon

Asansör Panoları

KOD	cinsi		KUTU ADET	ADET TL
Z01680X	Boş Asansör Panosu	350x450x130	1	Sorunuz
Z01681X	40 A. Asansör Panosu	350x450x130	1	Sorunuz
Z01682X	63 A. Asansör Panosu	350x450x130	1	Sorunuz

Priz ve Otomat Montajlı Şantiye Panoları

300x600x250

KOD	cinsi		KUTU ADET	ADET TL
Z01635X	Boş Şantiye Panosu	300x600x250	1	Sorunuz
Z01602X	3x25 A. 3 Ad. + 1x16 A. 3 Ad. Prizli	300x600x250	1	Sorunuz
Z01631X	5x16 A. 3 Ad. + 1x16 A. 3 Ad. Prizli	300x600x250	1	Sorunuz
Z01632X	5x32 A. 3 Ad. + 1x16 A. 3 Ad. Prizli	300x600x250		

3 Ad. 1x16 Makina Prizli - 3 Ad. Trifaze Makina Prizli ve Otomat Montajlı İstek Üzerine Schneider veya Chint Markalı Otomat Montajı Yapılır

Priz ve Otomat Montajlı Sayaç Takılabilir Şantiye Panoları

500x700x250

KOD	cinsi		KUTU ADET	ADET TL
Z01675X	Boş Şantiye Panosu	500x700x250	1	Sorunuz
Z01642X	3x25 A. 3 Ad. + 1x16 A. 3 Ad. Prizli	500x700x250	1	Sorunuz
Z01671X	5x16 A. 3 Ad. + 1x16 A. 3 Ad. Prizli	500x700x250	1	Sorunuz
Z01672X	5x32 A. 3 Ad. + 1x16 A. 3 Ad. Prizli	500x700x250	1	Sorunuz

3 Ad. 1x16 Makina Prizli - 3 Ad. Trifaze Makina Prizli ve Otomat Montajlı İstek Üzerine Schneider veya Chint Markalı Otomat Montajı Yapılır Sayaç Takılabilir.

Ledli Buzer Sinyaller Ø 22 mm



KOD	cinsi	KUTU ADET	ADET TL
150191X	Buzer Sinyal 220 V Ledli Ses İkazlı - Flaşörlü	10	160,00
150192X	Buzer Sinyal 24 V Ledli Ses İkazlı - Flaşörlü	10	160,00

Ledli Sinyal Lambası - Ampermetre - Voltmetre



LEDLİ

KOD	cinsi	KUTU ADET	ADET TL
155026X	22 mm 220 V Ledli Sinyal [Kırmızı-Sarı-Yeşil]	20	41,80
150320X	22 mm Ampermetre Sinyal Lambası	10	276,00
150321X	22 mm Voltmetre Sinyal Lambası	10	165,00
150322X	Dijital Voltmetre / Ampermetre Sinyal Lambası	10	460,00

Start - Stop Butonlar Ø 22 mm



KOD	cinsi	KUTU ADET	ADET TL
155004X	Start Buton NA	10	312,00
155005X	Stop Buton NK	10	312,00
155008X	Start - Stop İkiz Buton NA+NK	10	558,00

Mandallı Seçici Butonlar Ø 22 mm

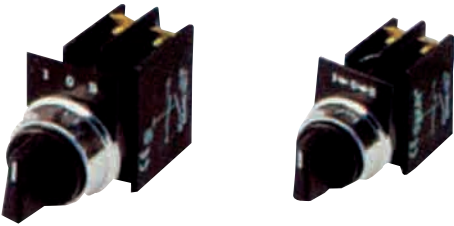

KOD	cinsi	KUTU ADET	ADET TL
155009X	0-1 Kalıcı Mandallı Buton NA	10	567,00
155010X	0-1 Kayıcı Mandallı Buton NA	10	567,00
155011X	1-0-2 Kalıcı Mandallı Buton NA+NA	10	635,00
155012X	1-0-2 Kayıcı Mandallı Buton NA+NA	10	635,00

Kilitli Acil Start - Stop Butonlar Ø 22 mm



155100X

155101X

155102X

KOD	cinsi	KUTU ADET	ADET TL
155100X	Kilitli Acil Stop Buton NK	12	555,00
155101X	Kilitli Acil Start Buton NA	12	555,00
155102X	Kilitli Acil Start + Stop - NA+NK	12	587,00

Start - Stop Butonlar Ø 22 mm

KOD	cinsi	KUTU ADET	ADET TL
150200X	Start Düz Buton NA	20	81,00
150201X	Stop Düz Buton NK	20	81,00
150014X	Start Kontak	20	37,00
150013X	Stop Kontak	20	37,00

KOD	cinsi	KUTU ADET	ADET TL
150210X	Start-Stop İkiz Buton NA+NK Işıksız	20	166,00
150211X	Start-Stop İkiz Buton NA+NK Işıklı	20	320,00

KOD	cinsi	KUTU ADET	ADET TL
150220X	Yaylı Start Buton Işıklı Ba9S 220V	20	227,00
150221X	Yaylı Stop Buton Işıklı Ba9S 220V	20	227,00

KOD	cinsi	KUTU ADET	ADET TL
150230X	İşaretli Yaylı Buton Beyaz →	20	150,00
150231X	İşaretli Yaylı Buton Siyah →	20	150,00
150232X	İşaretli Yaylı Sarı (Alarm)	20	150,00

KOD	cinsi	KUTU ADET	ADET TL
150233X	Acil Stop Kalıcı Mantar Buton	20	145,00

Mandallı Anahtarlı Butonlar Ø 22 mm

KOD	cinsi	KUTU ADET	ADET TL
150300X	Mandallı Kalıcı 2-0-1	20	117,00
150301X	Mandallı Kayıcı 2-0-1	20	130,00
150302X	Mandallı Kalıcı 0-1	20	80,00
150303X	Mandallı Kayıcı 0-1	20	92,00

KOD	cinsi	KUTU ADET	ADET TL
150310X	Anahtarlı Kalıcı 2-0-1	20	210,00
150311X	Anahtarlı Kayıcı 2-0-1	20	210,00
150312X	Anahtarlı Kalıcı 0-1	20	175,00
150313X	Anahtarlı Kayıcı 0-1	20	175,00

Etanj Buton Kutuları

IP44



KOD	cinsi	KUTU ADET	ADET TL
150001F	1'li Etanj Buton Kutusu Siyah G. IP44	45	99,50
150002F	2'li Etanj Buton Kutusu Siyah G. IP44	33	135,70
150003F	3'lü Etanj Buton Kutusu Siyah G. IP44	22	176,00
150004F	4'lü Etanj Buton Kutusu Siyah G. IP44	18	202,00

Mavi Gövdeli Etanj Kutuları

IP65

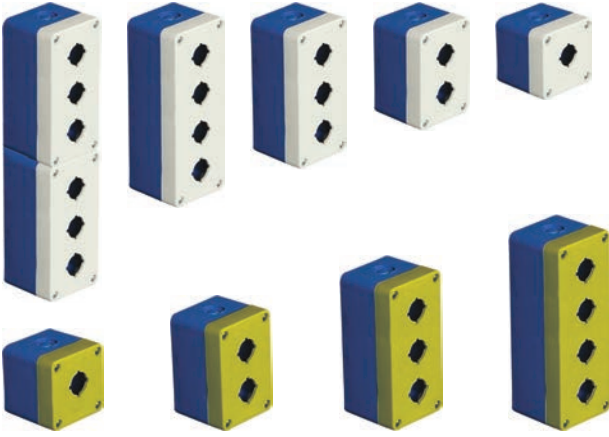

KOD	cinsi	KUTU ADET	ADET TL
150063F	1'li Etanj Kutusu Mavi Gövdeli IP65	45	107,30
150064F	2'li Etanj Kutusu Mavi Gövdeli IP65	33	146,80
150065F	3'lü Etanj Kutusu Mavi Gövdeli IP65	22	194,90
150066F	4'lü Etanj Kutusu Mavi Gövdeli IP65	18	216,60
150067F	5'li Etanj Kutusu Mavi Gövdeli IP65	9	350,00
150068F	6'lı Etanj Kutusu Mavi Gövdeli IP65	9	401,00
150069F	8'li Etanj Kutusu Mavi Gövdeli IP65	9	482,00

Sipariş Anında Renk Bildiriniz.

Contalı

Düz Kapaklı Etanj Kutular Mavi Gövdeli

IP65



KOD	cinsi	KUTU ADET	ADET TL
150005F	68x68 h:63 1'li Düz Kapaklı	45	109,50
150006F	99x68 h:63 2'li Düz Kapaklı	33	163,70
150007F	148x68 h:63 3'lü Düz Kapaklı	22	202,50
150008F	180x68 h:63 4'lü Düz Kapaklı	18	220,00

Contalı

Kutulu Butonlar ve Sinyaller

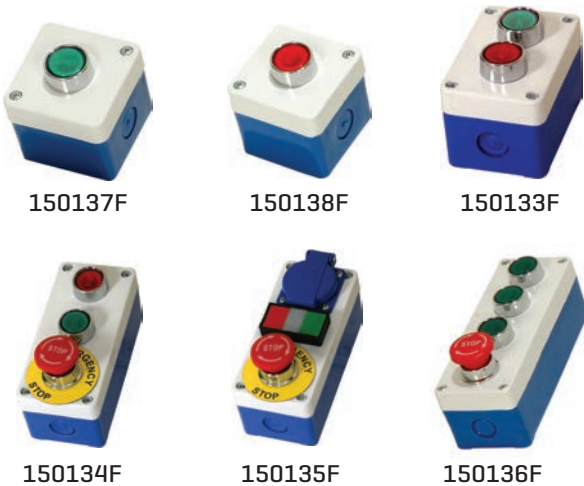

KOD	cinsi	KUTU ADET	ADET TL
150137F	Tekli Start Butonu Kutulu	30	207,00
150138F	Tekli Stop Butonu Kutulu	30	207,00
150133F	İkili Start - Stop Butonu Kutulu	28	339,00
150134F	Start+Stop+Acil Kilitlemeli Stop Butonu	14	552,00
150135F	1x16 A. Pano Prizi+İkiz Buton+ Acil Buton	14	663,00
150136F	3 Ad. Start + 1 Ad. Acil Stop Butonu	12	641,00

Kutulu Acil Start - Stop Butonları

150071F



150062F



150074F



150070X



150072F



150073F



155041X

KOD	cinsi	KUTU ADET	ADET TL
150071F	Kutulu Acil Kitlemeli NA Start Butonu	4	670,00
150062F	Kutulu Acil Kitlemeli NK Stop Butonu	4	274,90
150074F	Kutulu Acil Kitlemeli NA+NK Stop + Start Butonu	4	291,50
150070X	Emergency Etiket	50	26,00

KOD	cinsi	KUTU ADET	ADET TL
150072F	Kutulu Acil Yaylı Stop Emniyet Butonu	4	264,00
150073F	Kutulu Acil Yaylı Start Emniyet Butonu	4	264,00

KOD	cinsi	KUTU ADET	ADET TL
155041X	Push Butonu 4A [50x90x40]	10	886,00

Pedal Butonları

KOD	cinsi	KUTU ADET	ADET TL
155002X	Alüminyum Pedal NA Kontakt	1	2.805,00
155003X	Muhafazalı Pedal [Çift Emniyetli]	1	3.095,00
150340X	Plastik Pedal [100x62x32 - 2 mt Kablolu]	1	359,00
150341X	Sac Pedal [100x70x33 - 2 mt Kablolu]	1	397,00
150342X	Döküm Pedal [135x65x45 - 2 mt Kablolu]	1	446,00
150343X	Döküm Pedal [165x80x55 - 2 mt Kablolu]	1	539,00
150344X	Döküm Korumalı Pedal [200x100x130]	1	1.548,00
150345X	Döküm Korumalı Pedal [210x150x125]	1	1.920,00

Vinç Butonları

KOD	cinsi			KUTU ADET	ADET TL
150055X	2'li	Butonlu	NA-NK	1	1.508,00
150056X	3'lü	Butonlu	NA-NK	1	2.246,00
150057X	4'lü	Butonlu	NA-NK	1	3.143,00
150058X	6'li	Butonlu	NA-NK	1	3.714,00

KOD	cinsi			KUTU ADET	ADET TL
150076X	2'li	Acil Stop Butonlu	NA-NK	1	1.905,00
150077X	3'lü	Acil Stop Butonlu	NA-NK	1	2.643,00
150078X	4'lü	Acil Stop Butonlu	NA-NK	1	3.540,00
150079X	6'li	Acil Stop Butonlu	NA-NK	1	4.111,00

Kutulu Pako Şalterler



KOD	cinsi	KUTU ADET	ADET TL
150101F	1x10 A. Kutulu Pako Şalter 0-1	1	611,70
150102F	1x16 A. Kutulu Pako Şalter 0-1	1	705,00
150103F	1x25 A. Kutulu Pako Şalter 0-1	1	788,20

KOD	cinsi	KUTU ADET	ADET TL
150116F	3x10 A. Kutulu Pako Şalter 0-1	1	795,80
150117F	3x16 A. Kutulu Pako Şalter 0-1	1	946,00
150118F	3x25 A. Kutulu Pako Şalter 0-1	1	1.198,00
150119F	3x40 A. Kutulu Pako Şalter 0-1	1	1.369,00
150120F	3x63 A. Kutulu Pako Şalter 0-1	1	2.420,00
150121F	3x100 A. Kutulu Pako Şalter 0-1	1	3.740,00

Pako Kutuları



KOD	cinsi	KUTU ADET	ADET TL
150091F	1x10-3x10 A. Pako Kutusu [68x68x63]	45	166,40
150092F	3x16-3x25 A. Pako Kutusu [99x68x63]	33	176,50

0-1 Aç Kapa Pakolar İçin

150093F	Pako Şalter Kutusu 110x110x125	8	272,80
---------	--------------------------------	---	--------

Kullanılan Şalterler:
3x40-63-100 A. Aç Kapa Şalter
3x25-40 63 A. Enversör Şalter
3x25 Yıldız Üçgen Şalter

Topraklama Kontak Pozisyonları

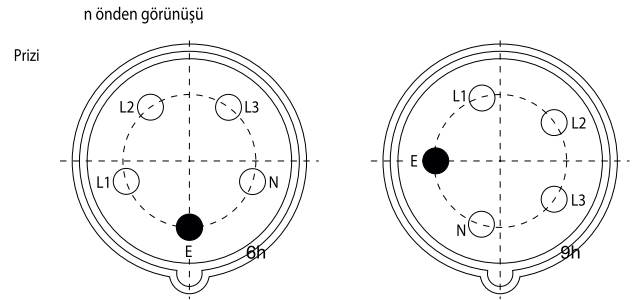
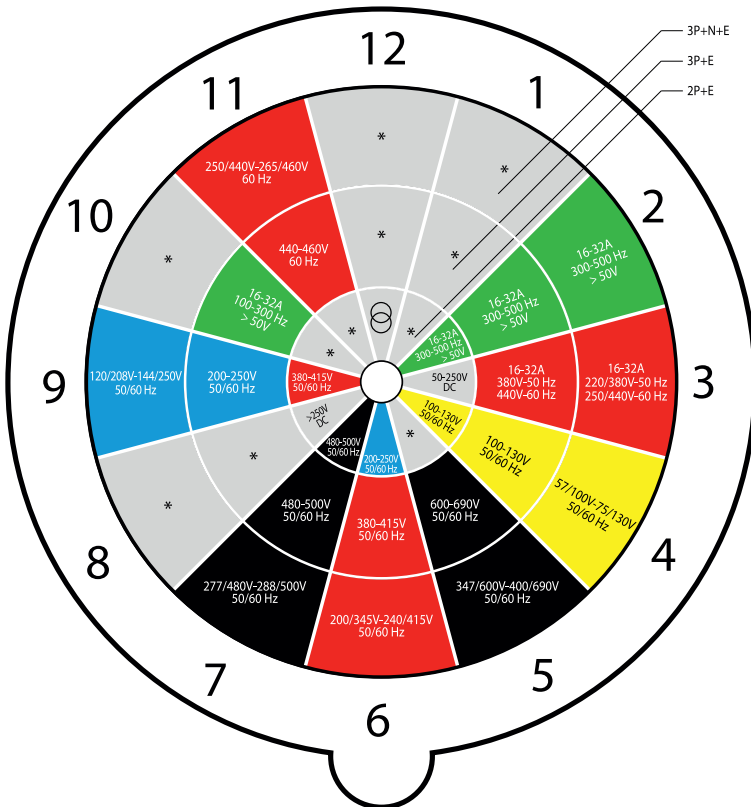

Norm kapsamına alınmamı ve özel uygulamalar için kullanılabilir.

Topraklama kontak pozisyonları (IEC 60309-2' ye göre)

Renk Kodları

20 - 25V	40 - 50V
100 - 130V	200 - 250V
380 - 480V	500 - 690V
60 - 500 Hz	

EMTIA ÜRÜNLER

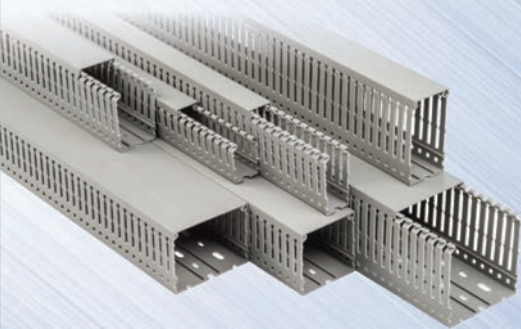

A	Anahtar Çeşitleri.....	73	M	Makaralar.....	70
	Aspiratörler.....	76		Makaslar.....	81
B	Baladozlar.....	72		Micro Switchler.....	73
	Bakalit Duylar.....	74	N	NH00 Kofra.....	71
	Bantlar.....	73		NH00 Buşonlar ve Altlıkları.....	71
	Basınç Şalterleri.....	75			
	Buşonlar ve Altlıkları.....	71			
Ç	Çivili Kroşeler.....	80			
D	Devre Kesener.....	73	P	Pano Fanları.....	76
	Duylar.....	74		Penseler.....	81
E	Eriyen Bantlar.....	73		Porselen Duylar.....	74
F	Fanlar.....	76		Porselen ve Polyester Buşonlar.....	71
	Filatör EKO.....	75		Prizler - Fişler.....	70-74
	Fişler - Prizler.....	70-74	S	Seyyar El Lambaları.....	72
	Floresan Zincir.....	73		Sirenler.....	72
G	Grup Prizler.....	69		Su Seviye Şalterleri EKO.....	75
H	Helezon Pano Spirali.....	75		SKP Sıkma Penseleri.....	81
İ	İkaz Butonları.....	72	Ş	Şamandıra EKO.....	75
	İzole Bantlar.....	73	T	Tepe Lambaları.....	72
	İzoleli Yüksükler.....	77-78		TV Fişleri.....	73
K			V	Vidalı Buat Klemensleri.....	75
	Kablo Bağları.....	77	Y	Yapışkan Kroşeler.....	77
	Kablo Toplama Spiralleri.....	75		Yüksükler.....	77-78
	Kablo Yüksükleri.....	77-78		Yük Kesicili Kofra.....	71
	Kablo Uçları.....	78-79	Z	Zil Butonları.....	75
	Kampana Zil.....	72			
	Kornalar.....	72			
	Kofralar.....	71			

Emtia Listesindeki Fiyatları Haber Vermeksizin Değişirme Hakkımızı Saklı Tutarız.

3'lü Grup Prizler (Çocuk Korumalı)

KOD	CİNSİ	KUTU AD.	ADET TL
Q00011	3'lü Top. Klemensli	40	255,00
Q00010	3'lü Top. Klemensli Anahtarlı	36	383,00
Q00031	3'lü Top. Kablolu [2m]	20	609,00
Q00036	3'lü Top. Kablolu [3m]	18	723,00
Q00038	3'lü Top. Kablolu [5m]	15	936,00
Q00030	3'lü Top. Kablolu Anahtarlı [2m]	18	751,00
Q00035	3'lü Top. Kablolu Anahtarlı [3m]	18	851,00
Q00037	3'lü Top. Kablolu Anahtarlı [5m]	15	1.092,00

4'lü Grup Prizler (Çocuk Korumalı)

KOD	CİNSİ	KUTU AD.	ADET TL
Q00041	4'lü Top. Klemensli	30	326,00
Q00040	4'lü Top. Klemensli Anahtarlı	30	454,00
Q00045	4'lü Top. Kablolu [2m]	16	709,00
Q00049	4'lü Top. Kablolu [3m]	15	823,00
Q00051	4'lü Top. Kablolu [5m]	14	1.050,00
Q00044	4'lü Top. Kablolu Anahtarlı [2m]	16	851,00
Q00048	4'lü Top. Kablolu Anahtarlı [3m]	15	965,00
Q00050	4'lü Top. Kablolu Anahtarlı [5m]	14	1.191,00

6'lı Grup Prizler (Çocuk Korumalı)

KOD	CİNSİ	KUTU AD.	ADET TL
Q00081	6'lı Top. Klemensli	20	468,00
Q00080	6'lı Top. Klemensli Anahtarlı	20	595,00
Q00085	6'lı Top. Kablolu [2m]	12	822,00
Q00089	6'lı Top. Kablolu [3m]	12	936,00
Q00091	6'lı Top. Kablolu [5m]	10	1.163,00
Q00084	6'lı Top. Kablolu Anahtarlı [2m]	12	964,00
Q00088	6'lı Top. Kablolu Anahtarlı [3m]	12	1.078,00
Q00090	6'lı Top. Kablolu Anahtarlı [5m]	10	1.305,00

Maxi 10'lu Topraklı Grup Prizler

KOD	CİNSİ	KUTU AD.	ADET TL
Q00261	Maxi 10'lu Top. Klemensli	20	946,00

Aksesuarlar



KOD	cinsi	KUTU AD.	ADET TL
Z00421	Topraklı Düz Fiş	50	60,00
Z00423	L Tipi Topraklı Eğik Fiş	60	69,40
Z00422	Topraklı Dişi Fiş	60	69,30
Z00425	L Tipi Anahtarlı Topraklı Fiş	50	194,60
Q00130	Yıldız 3'lü Fiş Priz Golyat	30	173,00
Q00000	3'lü Fiş Priz Düz Golyat Beyaz	30	220,00

Klasik Priz



KOD	cinsi	KUTU ADET	ADET TL
778028	S/Ü Topraklı Priz	20	113,90
625002	S/A Anahtarlı Topraklı Priz	6	235,70
778012	2'li Topraklı Priz Monoblok	6	273,00

Monofaze Pls. Boş Makara [4 Adet 1x16 A Prizli]



KOD	PRİZLER	PRİZ AD.	KABLO CİNSİ ve ÖLÇÜSÜ	KUTU ADET	ADET TL
Q00161	1x16 A	4	3x2,5 TTR 50 mt. Kapasiteli	2	755,00

Siparişe Göre TSE'li Kablo Montajı Yapılır.
Fransız ve Universal Tip Makara için Fiyat Alınır.
Göbek Rengi Değişiklik Gösterebilir.

Monofaze Metal Boş Makara [4 Adet 1x16 A Prizli]



KOD	PRİZLER	PRİZ AD.	KABLO CİNSİ ve ÖLÇÜSÜ	KUTU ADET	ADET TL
Q00171	1x16 A	4	3x2,5 TTR 50 mt. Kapasiteli	2	1.439,00

Siparişe Göre TSE'li Kablo Montajı Yapılır.
Fransız ve Universal Tip Makara için Fiyat Alınır.
Göbek Rengi Değişiklik Gösterebilir.

Polyester Kofralar



KOD	cinsi	KUTU AD.	ADET \$
H00081	Polyester Kofra [NH00 Altıklı]	6	48,00 \$
H00082	Yük Kesicili Polyester Kofra	6	62,00 \$

Porselen NH00 Boy Sigorta Buşonları



KOD	AMPER	KUTU AD.	ADET \$
H00001	32 A	10	7,35 \$
H00002	40 A	10	7,35 \$
H00003	50 A	10	7,35 \$
H00004	63 A	10	7,35 \$
H00005	80 A	10	7,35 \$
H00006	100 A	10	7,35 \$
H00007	125 A	10	7,35 \$
H00008	160 A	10	7,35 \$

Porselen NH00 Boy Altıklar



KOD	cinsi	KUTU AD.	ADET \$
H00010	Porselen NH00 Boy Altık	6	10,40 \$

Polyester NH00 Boy Sigorta Buşonları



KOD	AMPER	KUTU AD.	ADET \$
H00043	32 A	10	6,00 \$
H00044	40 A	10	6,00 \$
H00045	50 A	10	6,00 \$
H00046	63 A	10	6,00 \$
H00047	80 A	10	6,00 \$
H00048	100 A	10	6,00 \$
H00049	125 A	10	6,00 \$
H00050	160 A	10	6,00 \$

Polyester NH00 Boy Altıklar



KOD	cinsi	KUTU AD.	ADET \$
H00051	Polyester NH00 Boy Klemensli Altık	6	5,60 \$



773003-04



773019



Kornalar

KOD	cinsi	KUTU AD.	ADET TL
773004	Alarm Plastik Korna 220 V	20	1.180,00
773003	Alarm Döküm Korna 220 V	20	1.416,00
773019	İkaz Korna 220 V	20	860,00

İkaz Butonları

KOD	cinsi	KUTU AD.	ADET TL
773009	Kare Yangın İhbar Butonu	1	290,00
773010	Kare Yangın İhbar Butonu Çekiçli	1	-
773066	Reset. Kapaksız Yangın İhbar Butonu 220V	1	1.300,00

Sirenler

KOD	cinsi	KUTU AD.	ADET TL
773006	S1 Motorlu Siren Metal	1	3.160,00
773014	S2 Motorlu Siren Metal	1	3.900,00
773007	S3 Motorlu Siren Metal	1	25.300,00
773008	S1 Motorlu Siren Plastik	1	2.650,00
773016	S2 Motorlu Siren Plastik	1	2.850,00

Elektronik Siren

KOD	cinsi	KUTU AD.	ADET TL
773072	Ledli Elektronik Siren 220 V AC-24 V DC	1	910,00

Seyyar El Lambaları

KOD	cinsi	KUTU AD.	ADET TL
773028	Seyyar El Lambası Duyulu Anahtarsız	25	22,10 \$
773029	Seyyar El Lambası Duyulu Anahtarlı	25	28,40 \$

Tepe Lambaları

KOD	cinsi	KUTU AD.	ADET \$
773018	Döner Flaşörlü Tepe Lambası 220 V	1	80,20 \$
773065	Döner Flaşörlü Tepe Lambası 24 V	1	64,20 \$

Kampana Zil

KOD	cinsi	KUTU AD.	ADET TL
773011	Kampana Zil 220 V	1	1.965,00

12-24 V Mevcuttur, Fiyat Alınız.

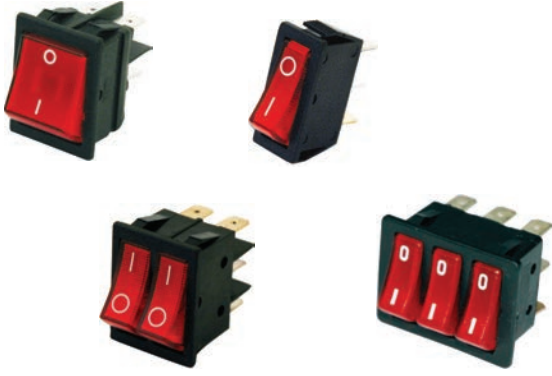

Anahtar Çeşitleri

KOD	cinsi	KUTU AD.	ADET TL
112101	Işıksız Tekli Anahtar	50	36,50
112102	Işıksız Geniş Tekli Anahtar	50	65,70
112103	Işıksız Çiftli Anahtar	50	65,70
112104	Işıksız Üçlü Anahtar	50	111,00
112105	Işıklı Tekli Anahtar Kırmızı	50	87,60
112106	Işıklı Geniş Tekli Anahtar Kırmızı	50	69,40
112107	Işıklı Çiftli Anahtar Kırmızı	50	87,60
112108	Işıklı Üçlü Anahtar Kırmızı	50	131,40

Kırmızı Renkler Haricindeki Renkler Kutu olarak Satılır

Zincir



KOD	cinsi	AMBALAJ	ADET TL
152018	Floresan Zinciri	100 mt	17,70

Bantlar



KOD	cinsi	KUTU AD.	ADET \$
101376	İzole Bant 10x19 mm	500	0,70 \$
101197	Eriyen Bant 19x0,8x8 mm	50	4,55 \$
101377	Eriyen Bant 50x0,8x8 mm	50	11,80 \$

TV Fişleri



KOD	cinsi	KUTU AD.	ADET TL
101632	F-Konnektör RG 6 Vida	100	8,70
101633	F-Konnektör RG 59 Vida	100	8,70
101636	F-F Ara Konnektör	100	8,70
101637	F-T Konnektör	50	59,00
101626	Uydu Dağıtıcı 2 li Splinter	10	171,00
101627	Uydu Dağıtıcı 3 lü Splinter	10	205,00
101628	Uydu Dağıtıcı 4 lü Splinter	10	246,00
101629	Uydu Dağıtıcı 8 li Splinter	10	-

Devrekesen



KOD	cinsi	KUTU AD.	ADET TL
502421	AKS-01 Kapalı Kontak Kapı Switch NK	50	102,00
502422	AKS-10 Açık Kontak Kapı Switch NA	50	102,00

Micro Switchler



KOD	cinsi	KUTU AD.	ADET \$
502401	Makaralı Palet Switch	20	5,10 \$
502403	Makaralı Kısa Palet Switch	20	5,10 \$
502404	Düz Makaralı Pim Switch	20	5,90 \$
502405	Düz Pim Switch	20	5,65 \$

Micro Switch Çeşitleri Mevcuttur



Emtia Ürünler

KOD	cinsi	KUTU AD.	ADET TL
778006	Duy Fiş	50	41,40
778015	500 W Halojen Duy	50	195,00
778016	1000 W Çubuk Halojen Duy	50	260,00
778034	5'li Dağıtıcı Fiş	50	58,00
778057	İngiliz Fiş	50	56,50
778008	Ara Puar	50	45,00
101950	Deney Okul Seti	50	92,90
778010	Üniversal Adaptör	50	108,00
778013	Amerikan Fiş	100	-

Bakalit Duylar

KOD	cinsi	KUTU AD.	ADET TL
778029	E27 Yağmur Duy	50	36,00
101081	E27 Bakalit Asma Duy	50	31,50
101079	E27 Bronz Duy	50	160,00
101082	E27 Bakalit Tavan Glop Dibi	24	62,90
101085	E27 Bakalit Duvar Glop Dibi	24	62,90
101083	E27 Bakalit Tavan Duy	40	42,90
101084	E27 Bakalit Duvar Duy	40	42,90
101152	E14 Donanma Duy	100	56,85
101086	E14 Mum Duy	100	37,00
101080	E14 Bronz Duy	100	160,00



Porselen Duylar

KOD	cinsi	KUTU AD.	ADET TL
650156	E27 Porselen Tavan Duy	15	150,00
650157	E27 Porselen Duvar Duy	15	150,00
650158	E27 Porselen Tavan Glop Dibi	6	215,00
650159	E27 Porselen Duvar Glop Dibi	6	215,00
650153	E27 Porselen M10 Braçol Duy	24	195,00
650154	E27 Porselen 3/8 Braçol Duy	24	195,00
650155	E27 Porselen Donanma Duy	15	150,00
650152	E27 Porselen Yağmur Duy	24	130,00





Su Seviye Şalterleri - Eko

KOD	cinsi	KUTU AD.	ADET TL
116001	1.6 mt Kablolü Switchli - Monofaze	1	616,00
116003	3 mt Kablolü Switchli - Monofaze	1	800,00
116005	5 mt Kablolü Switchli - Monofaze	1	1.059,00
116007	10 mt Kablolü Switchli - Monofaze	1	1.712,00
116008	15 mt Kablolü Switchli - Monofaze	1	2.488,00

Ürün Renk Değişikliği Gösterebilir

Trifaze Basınç Şalterleri Tahliyelii

KOD	cinsi	KUTU AD.	ADET TL
101653	1-5 Bar 1,0 - 3,0 Bar 16 A 400 V	1	Sorunuz
101654	1-8 Bar 1,0 - 3,0 Bar 16 A 400 V	1	Sorunuz
101655	3-11 Bar 1,2 - 3,5 Bar 16 A 400 V	1	Sorunuz
101656	4-16 Bar 1,4 - 4,0 Bar 16 A 400 V	1	Sorunuz

Dekoratif Zil Butonları

KOD	cinsi	KUTU AD.	ADET TL
778041	1'li Dekoratif Zil Paneli	20	175,00
778042	2'li Dekoratif Zil Paneli	20	315,00
778043	3'lü Dekoratif Zil Paneli	15	472,00
778044	4'lü Dekoratif Zil Paneli	10	630,00
778045	5'li Dekoratif Zil Paneli	10	786,00
778046	6'lı Dekoratif Zil Paneli	10	930,00
778047	7'li Dekoratif Zil Paneli	10	1.100,00
778048	8'li Dekoratif Zil Paneli	10	1.260,00
778049	9'lu Dekoratif Zil Paneli	10	1.415,00
778050	10'lu Dekoratif Zil Paneli	10	1.572,00
778051	11'li Dekoratif Zil Paneli	4	Sorunuz
778052	12'li Dekoratif Zil Paneli	4	Sorunuz

Helezon Pano Spirali

KOD	cinsi	KUTU AD.	METRE TL
152171	No: 1 Helezon Pano Spirali	1	8,90
152172	No: 2 Helezon Pano Spirali	1	10,90
152173	No: 3 Helezon Pano Spirali	1	13,00
152174	No: 4 Helezon Pano Spirali	1	16,00
152175	No: 5 Helezon Pano Spirali	1	28,00

Vidalı Buat Klemensleri

KOD	cinsi	KUTU AD.	ADET TL
555551	No: 1 Vidalı Buat Klemensi	1000	1,32
555552	No: 2 Vidalı Buat Klemensi	1000	1,51
555553	No: 3 Vidalı Buat Klemensi	500	2,20
555554	No: 4 Vidalı Buat Klemensi	500	3,70
555555	No: 6 Vidalı Buat Klemensi	500	5,40



Pano Fanları

KOD	cinsi			KUTU AD.	ADET \$
107051	220 V Pano Fanı	APF	120x120x38	1	8,00 \$
107052	220 V Pano Fanı	APF	172x150x51	1	20,00 \$



Dekoratif Cam ve Duvar Tipi Aspiratörler

KOD	cinsi			KUTU AD.	ADET TL
107100	EF1009		100	1	620,00
107101	EF1219		120	1	730,00
107102	EF1530		150	1	950,00



Kapaklı Aspiratörler

KOD	Tipi	ÇAP	MOTOR GÜCÜ (W)	MOTOR DEVRİ D/DAK.)	DEBİ (m³/h)	KUTU AD.	ADET TL
107001	16 KA	16	40 W	1400	180	1	4.270,00
107002	20 KA	20	40 W	1400	320	1	4.640,00
107003	25 KA	25	40 W	1400	780	1	5.200,00
107004	30 KA	30	50 W	1400	1300	1	5.760,00



Cam Tipi Aspiratörler

KOD	Tipi	ÇAP	MOTOR GÜCÜ (W)	MOTOR DEVRİ D/DAK.)	DEBİ (m³/h)	KUTU AD.	ADET TL
107005	16 CA	16	40 W	1400	180	1	4.085,00
107006	20 CA	20	40 W	1400	320	1	4.460,00
107007	25 CA	25	40 W	1400	780	1	5.014,00
107008	30 CA	30	50 W	1400	1300	1	5,571,00



Baca Tipi Aspiratörler

KOD	Tipi	ÇAP	MOTOR GÜCÜ (W)	MOTOR DEVRİ D/DAK.)	DEBİ (m³/h)	KUTU AD.	ADET TL
107111	16 BA	16	40 W	1400	180	1	3.900,00
107112	20 BA	20	40 W	1400	320	1	4.270,00
107113	25 BA	25	40 W	1400	780	1	4.830,00
107114	30 BA	30	50 W	1400	1300	1	5.200,00
107115	35 BA	35	50 W	1400	1900	1	5.570,00



Kanal Tipi Aspiratörler

KOD	Tipi	ÇAP	MOTOR GÜCÜ (W)	MOTOR DEVRİ D/DAK.)	DEBİ (m³/h)	KUTU AD.	ADET TL
107121	16 B0	16	40 W	1400	180	1	4.270,00
107122	20 B0	20	40 W	1400	320	1	4.640,00
107123	25 B0	25	40 W	1400	780	1	5.200,00
107124	30 B0	30	50 W	1400	1300	1	5.570,00
107125	35 B0	35	50 W	1400	1900	1	6.130,00

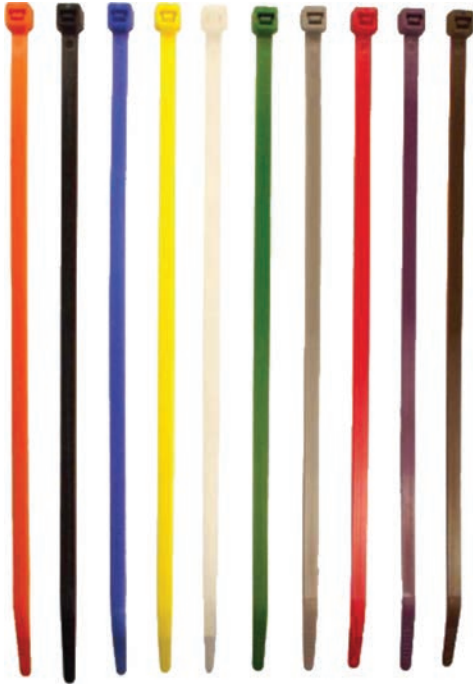

Kablo Bağları

KOD	TAŞIMA KAP. [kg]	RENK ve ÖLÇÜLER	KUTU AD.	ADET TL
502002	8	Beyaz/Siyah 2,5x100	100	0,320
502004	8	Beyaz/Siyah 2,5x150	100	0,470
502005	8	Beyaz/Siyah 2,5x200	100	0,690
502006	18	Beyaz/Siyah 3,6x140	100	0,720
502008	18	Beyaz/Siyah 3,6x200	100	1,140
502009	18	Beyaz/Siyah 3,6x250	100	1,320
502010	18	Beyaz/Siyah 3,6x280	100	1,630
502012	18	Beyaz/Siyah 3,6x370	100	2,040
502015	22	Beyaz/Siyah 4,8x200	100	1,530
502016	22	Beyaz/Siyah 4,8x250	100	1,900
502017	22	Beyaz/Siyah 4,8x300	100	2,220
502018	22	Beyaz/Siyah 4,8x370	100	2,780
502020	22	Beyaz/Siyah 4,8x430	100	3,340
502022	55	Beyaz/Siyah 7,6x300	100	4,670
502023	55	Beyaz/Siyah 7,6x370	100	5,480
502024	55	Beyaz/Siyah 7,6x450	100	6,400
502025	55	Beyaz/Siyah 7,6x550	100	8,270
502028	80	Beyaz/Siyah 9,0x600	100	12,180
502029	80	Beyaz/Siyah 9,0x710	100	14,950
502030	80	Beyaz/Siyah 9,0x900	100	18,250

Renkli Plastik ve Çelik Kablo Bağları İçin Fiyat Alınız.



Yapışkan Kroşe

KOD	ciinsi	KUTU AD.	ADET TL
502051	19x19 mm Beyaz Yapışkan Kroşe	100	1,770
502053	28x28 mm Beyaz Yapışkan Kroşe	100	3,200

Tek Girişli İzoleli Yüksükler



KOD	RENK	KESİT mm ²	UZUNLUK mm.	KUTU AD.	ADET TL
502061	Beyaz / Turuncu	0,50	12	1000	0,540
502062	Mavi / Beyaz	0,75	14	1000	0,540
502063	Kırmızı / Sarı	1,00	14	1000	0,540
502064	Siyah / Kırmızı	1,50	14	1000	0,590
502065	Gri / Mavi	2,50	14	500	0,760
502066	Turuncu / Gri	4,00	14	500	1,270
502067	Yeşil / Siyah	6,00	17	250	1,750
502068	Bej / Kahverengi	10,00	20	100	2,200
502069	Bej / Yeşil	16,00	22	100	3,050
502070	Siyah / Kahverengi	25,00	24	50	5,100
502071	Kırmızı / Bej	35,00	28	50	6,350
502072	Mavi / Yeşil	50,00	30	25	11,700



Çift Girişli İzoleli Yüksükler

KOD	RENK	KESİT mm ²	UZUNLUK mm.	KUTU AD.	ADET TL
502091	Beyaz / Turuncu	2x0,50	14	1000	0,960
502092	Mavi / Beyaz	2x0,75	14	500	1,030
502093	Kırmızı / Sarı	2x1,00	14	500	1,070
502094	Siyah / Kırmızı	2x1,50	14	500	1,320
502095	Gri / Mavi	2x2,50	14	250	2,100
502096	Turuncu / Gri	2x4,00	17	200	2,430
502097	Yeşil / Siyah	2x6,00	20	100	3,020
502098	Bej / Kahverengi	2x10,00	27	50	4,620
502099	Bej / Yeşil	2x16,00	31	50	5,850

İzolesiz Yüksükler

KOD	KESİT mm ²	UZUNLUK mm.	KUTU AD.	ADET TL
502111	0,50	10	2000	0,540
502112	0,75	10	2000	0,540
502113	1,00	10	2000	0,590
502114	1,50	10	2000	0,610
502115	2,50	12	2000	0,830
502116	4,00	12	1000	1,120
502117	6,00	12	500	1,510
502118	10,00	15	200	1,530
502119	16,00	15	200	3,120
502120	25,00	16	100	4,570
502121	35,00	16	100	5,220



Çatal Tip İzoleli Kablo Uçları

KOD	CİNSİ	ÇATAL UCU	RENK	KABLO KESİTİ mm ²	KUTU AD.	ADET TL
502131	EÇU-3001	3,2	Kırmızı	0,5-1,5	200	2,350
502132	EÇU-4001	4,3	Kırmızı	0,5-1,5	200	2,390
502133	EÇU-5001	5,3	Kırmızı	0,5-1,5	200	2,480
502134	EÇU-6001	6,5	Kırmızı	0,5-1,5	200	2,820
502141	EÇU-3002	3,2	Mavi	1,5-2,5	200	2,580
502142	EÇU-4002	4,3	Mavi	1,5-2,5	200	2,680
502143	EÇU-5002	5,3	Mavi	1,5-2,5	200	2,780
502144	EÇU-6002	6,5	Mavi	1,5-2,5	200	3,600
502161	EÇU-4006	4,3	Sarı	4-6	75	5,850
502162	EÇU-5006	5,3	Sarı	4-6	75	6,000
502163	EÇU-6006	6,5	Sarı	4-6	75	7,800
502164	EÇU-8006	8,4	Sarı	4-6	75	9,250



Dişi Faston Tip İzoleli Kablo Uçları

KOD	CİNSİ	UZUNLUK mm	RENK	KABLO KESİTİ mm ²	KUTU AD.	ADET TL
502231	EFD-1288	19	Kırmızı	0,5-1,5	200	1,610
502232	EFD-1488	19,4	Kırmızı	0,5-1,5	200	2,050
502233	EFD-1638	20,8	Kırmızı	0,5-1,5	200	2,680
502234	EFD-2288	19	Mavi	1,5-2,5	150	2,050
502235	EFD-2488	19,4	Mavi	1,5-2,5	150	2,140
502236	EFD-2638	20,8	Mavi	1,5-2,5	150	2,680
	EFD-5638	23,3	Sarı	4-6	100	3,050





Erkek Faston Tip Kablo Uçları

KOD	cinsi	UZUNLUK mm	RENK	KABLO KESİTİ mm ²	KUTU AD.	ADET TL
502173	EFE-1288	19,2	Kırmızı	0,5-1,5	200	1,710
502174	EFE-1488	19,8	Kırmızı	0,5-1,5	200	1,950
502175	EFE-1638	21,8	Kırmızı	0,5-1,5	200	2,450
502176	EFE-2288	19,8	Mavi	1,5-2,5	200	1,710
502177	EFE-2488	19,8	Mavi	1,5-2,5	200	2,200
502178	EFE-2638	21,8	Mavi	1,5-2,5	200	2,590
502179	EFE-5638	24,8	Sarı	4-6	100	3,050

İzoleli Yuvarlak Kablo Uçları

KOD	cinsi	ÇİVATA ÇAPI	RENK	KABLO KESİTİ mm ²	KUTU AD.	ADET TL
502191	EYU-301	3,2	Kırmızı	0,5-1,5	200	1,750
502192	EYU-351	3,7	Kırmızı	0,5-1,5	200	1,750
502193	EYU-401	4,3	Kırmızı	0,5-1,5	200	2,530
502194	EYU-501	5,3	Kırmızı	0,5-1,5	200	2,580
502195	EYU-601	6,5	Kırmızı	0,5-1,5	200	4,100
502196	EYU-801	8,4	Kırmızı	0,5-1,5	200	4,110



502201	EYU-302	3,2	Mavi	1,5-2,5	200	3,120
502202	EYU-402	4,3	Mavi	1,5-2,5	200	3,160
502203	EYU-502	5,3	Mavi	1,5-2,5	200	3,210
502204	EYU-602	6,5	Mavi	1,5-2,5	200	4,570
502205	EYU-802	8,4	Mavi	1,5-2,5	200	4,590
502206	EYU-1002	10,5	Mavi	1,5-2,5	100	4,680

502221	EYU-406	4,3	Sarı	4-6	75	6,620
502222	EYU-506	5,3	Sarı	4-6	75	6,666
502223	EYU-606	6,5	Sarı	4-6	75	7,490
502224	EYU-806	8,4	Sarı	4-6	75	9,750
502225	EYU-1006	10,5	Sarı	4-6	75	9,850
502226	EYU-1206	13	Sarı	4-6	75	9,920

Çivili Kroşeler



KOD	cinsi	KUTU AD.	ADET TL
555120	No:0 Yassı Kordon için	1000	1,238
555121	No:1 Yuvarlak Kordon için	1000	1,238
555122	No:2 TTR/075	1000	1,238
555123	No:3 2x1,5 Antigron	1000	1,651
555124	No:4 2x4 Antigron	1000	1,651
555125	No:5 4x4 Antigron	1000	2,063
555126	No:6 4x6 Antigron	1000	2,063
555127	No:7 4x10 Antigron	1000	3,508
555128	No:8 3x16+10 Antigron	1000	4,952
555129	No:9 3x25+16 Antigron	1000	6,603

Ø 3,5 Çinko Sunta Vidaları

KOD	ÇAP x BOY	KUTU AD.	ADET TL
103093	3,5x16	1000	0,555
103094	3,5x18	1000	0,555
103095	3,5x20	1000	0,555
103096	3,5x25	1000	0,639
103097	3,5x30	1000	0,676
103098	3,5x35	1000	0,789
103099	3,5x40	500	0,870

Ø 4 Çinko Sunta Vidaları

KOD	ÇAP x BOY	KUTU AD.	ADET TL
103104	4x20	1000	0,670
103105	4x25	1000	0,759
103106	4x30	500	0,879
103107	4x35	500	0,981
103108	4x40	500	1,087
103109	4x45	500	1,185
103110	4x50	500	1,287
103111	4x60	300	1,601

Ø 4,5 Çinko Sunta Vidaları

KOD	ÇAP x BOY	KUTU AD.	ADET TL
103115	4,5x30	500	1,260
103116	4,5x35	500	1,440
103117	4,5x40	500	1,522
103118	4,5x45	500	1,707
103119	4,5x50	500	1,850
103120	4,5x60	200	2,120

Ø 5 Çinko Sunta Vidaları

KOD	ÇAP x BOY	KUTU AD.	ADET TL
103124	5x30	300	1,420
103125	5x35	300	1,460
103126	5x40	300	1,646
103127	5x45	300	1,830
103128	5x50	200	1,954
103129	5x60	200	2,304



Hidrolik SKP Sıkma Penseleri Çantalı

KOD	cinsi	KUTU AD.	ADET \$
502251	YQK-70 / 10-70 mm ² Çantalı	1	110,00 \$
502252	YQK-120 / 10-120 mm ² Çantalı	1	141,00 \$
502254	YQK-300 / 16-300 mm ² Çantalı	1	151,00 \$
502255	CY0-400 / 16-400 mm ²	1	-



İzoleli Yüksük Sıkma Penseleri

KOD	cinsi	KUTU AD.	ADET \$
502291	AN-04WFL / 0,5-6 mm ²	1	68,10 \$
502292	AN-35WF / 10-35 mm ²	1	63,20 \$



İzoleli Faston Yüksük Sıkma Pensesi

KOD	cinsi	KUTU AD.	ADET \$
502301	ANC-03C / 0,5-6 mm ²	1	56,50 \$



Konnektör Sıkma Pensesi

KOD	cinsi	KUTU AD.	ADET \$
502311	G-2096C 6/8 Pin Konnektör Sıkma Pensesi	1	40,00 \$



Tekli Kablo Sıyırma Pensesi

KOD	cinsi	KUTU AD.	ADET \$
502321	HY-369A / 0,5-2 mm ²	1	34,10 \$



502331

502341

502342

Kesme Makasları

KOD	cinsi	KUTU AD.	ADET \$
502331	TC-100 / 120 mm ² Kablo Kesme Makası	1	73,00 \$
502341	TC-250 / 250 mm ² Kablo Kesme Makası	1	140,00 \$
502342	TC-500 / 630 mm ² Kablo Kesme Makası	1	202,00 \$



53 yıldır bizimle birlikte güvenle yürüyen,
kymetli iş ortaklarımıza sonsuz teşekkürlerimizi sunarız.

KAİM MÜHENDİSLİK MÜŞAVİRLİK SAN. TİC. LTD. ŞTİ

Merkez:

Büyük Hendek Caddesi Kule İş Merkezi No:29 Kat: 4 - 5 Kuledibi - Beyoğlu / İstanbul
Tel: +90 212 293 93 12 e-mail: info@kaim.com.tr

Fabrika:

1. Organize Sanayi Bölgesi 5. Cadde No:6 Bilecik
Tel: +90 228 216 03 00-01 e-mail: info@kaim.com.tr

KAİM ENERJİ SANAYİ TİCARET ANONİM ŞİRKETİ

Satış:

Perpa Ticaret Merkezi A Blok Kat: 7-8 No: 771-773 Okmeydanı - Şişli / İstanbul
Tel: +90 212 222 88 55-56-57 e-mail: satis@kaim.com.tr